

112W145

Form 2895w
(149)
Printed in U. S. A.

LIST OF PARTS



From the library of: Diamond Needle Corp

MACHINE No. 112w145

** A TRADE MARK OF
THE SINGER MANUFACTURING COMPANY

INSTRUCTIONS FOR OILING

To ensure easy running and prevent unnecessary wear of the parts which are in movable contact, the machine requires oiling and when in continuous use, "TYPE B" or "TYPE D" OIL, sold only by Singer Sewing Machine Company, should be applied at least twice each day to all oil holes marked "OIL", as instructed in Form 2428w.

INDEX

	PAGE
ACCESSORIES	15
ATTACHMENT SLIDE PLATES	17
BOBBIN WINDERS	15 & 17
FEED DOGS	18
FOOT LIFTER	28
KNEE LIFTER	16
MACHINE NO. 112w145	5
MISCELLANEOUS PARTS	29
NEEDLE HOLDERS	18
NUMERICAL LIST OF PARTS	31
PRESSER FEET	19
THREAD UNWINDER	16
THROAT PLATES	25

From the library of: Diamond Needle Corp

Copyright, U. S. A., 1939, 1940, 1941,
1945 and 1949

by The Singer Manufacturing Co.

All Rights Reserved for all Countries

INSTRUCTIONS FOR ORDERING

In ordering from this list, use **ONLY** the **PART** number in the **FIRST** column.

The number stamped on a Sewing Machine Part is the number of the Single Part only, except when the part includes Set Screws, Clamping Screws, Studs and Rollers Spun on, Small Wires riveted, or Parts soldered together, etc., which it is necessary to furnish in combination.

Every combination of parts sent out has its specific number which, although not stamped on Parts (except in above case), must be used when ordering the combination.

Each number always indicates the **SAME PART** in whatever list it appears, or for whatever Machine.

The letters after some of the numbers indicate the style of finish only, as follows:

- A. Hardened, Polished, Nickel Plated and Buffed.
- B. Polished, Nickel Plated and Buffed.
- C. Hardened only.
- D. Polished only.
- E. Soft, not polished.
- F. Hardened and Polished.
- H. Blued.
- J. Nickel Plated only.
- R. Merlized.
- X. Black Oxide, for Iron and Steel.
- XC. Hardened and Black Oxide, for Iron or Steel.
- Y. Black Nickel Plated only.

These letters **MUST BE USED** when they appear in the list and **AFTER** the number, as in the list.

In this series

1 to 1500, 200001 to 201500 and 350001 to 351500 are Screw Numbers.
 1501 to 1800, 201501 to 201800 and 351501 to 351800 are Nut Numbers.
 1801 to 2000, 201801 to 202000 and 351801 to 352000 are Roller Numbers.
 2001 to 50000 and 202001 to 350000 are Numbers of Machine Parts.

The figures in the second column refer only to the plate in which the illustration of the part is shown and are **NOT TO BE USED** in ordering.

Two or more numbers over a cut indicate that the difference between such parts is not visible in an illustration.

Parts marked with an asterisk (*) are furnished only when repairs are made at the factory.

LIST OF PARTS COMPLETE

FOR

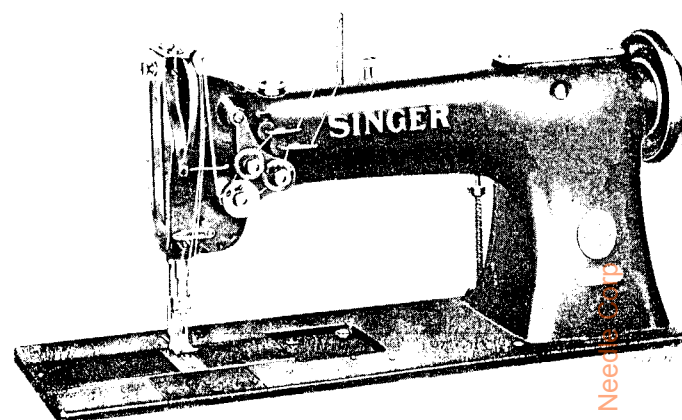

MACHINE No. 112w145

TWO NEEDLE. HIGH SPEED.

BALL BEARING. DROP FEED.

FOR SHIRTS, CORSETS, UNDERWEAR, ETC.

IN GAUGES FROM 1/32 TO 1 1/2 INCHES.

No.	Plate	Name
*248501	-----	Arm with 202135
202247	17817	" Cap
200278H	17817	" " Screw
202248	17817	" " Washer
204235	17818	" Position Pin (2)
200004E	17818	" Screw (3)
202005	17818	" " Washer (3)
248440	17817	" Shaft with 224392 and 350431E
249440	17817	" " Ball Bearing
*240054	17817	" " " " Collar with two 200378C
240055	17817	Arm Shaft Ball Bearing Collar 240054 with 249440
200378C	17817	Arm Shaft Ball Bearing Collar Set Screw
*240056	17817	Arm Shaft Ball Bearing Retaining Washer
236699	17817	Arm Shaft Bushing (back, ball bearing) complete, Nos. 236698, 240055 and 240056

From the library of: Diamond Needle Co.

No.	Plate	Name
*236698	17817	Arm Shaft Bushing (back)
200071E	17817	" " " " Screw (3)
263096	17817	" " " " (front) with 223847
223847	17817	" " " " Oil Packing (wick)
200502H	17817	Arm Shaft Bushing (front) Oil Packing Thumb Screw
204329	17817	Arm Shaft Bushing (front) Oil Pad
200341C	17817	" " " " Set Screw
224195	17818	" " Connection Belt
224104	17818	" " " " Pulley with 200327C, 200602C and two 202253
200602C	17818	Arm Shaft Connection Belt Pulley Position Screw
200327C	17818	Arm Shaft Connection Belt Pulley Set Screw
202253	17818	Arm Shaft Connection Belt Pulley Spring Flange
224139	17812	Arm Shaft Connection Belt Timing Plate
200164B	17812	" " " " " " " Screw (2)
224392	17817	Arm Shaft Oil Packing (wick)
350431E	17817	" " " " Stop Screw
224144	17813	Attachment Slide Plate with 213479 and 236061
236061	17813	Attachment Slide Plate Friction Slide
213479	17813	" " " " " " " Spring
248402	17817	Balance Wheel (disc) (belt groove 2-1/8 in. diam.) with 200328C and 200335C
Note:	Balance Wheel 248402 is furnished with this machine unless otherwise specified on order	
248456	17817	Balance Wheel (disc) "V" belt groove (outside diam. of belt groove 2.9 in.) with 201346C and 350107C
350419H	17817	Balance Wheel Adjusting Screw
200328C	17817	" " Position Screw
350107C	17817	" " " " "
200335C	17817	" " Set Screw
201346C	17817	" " " " "
*248403	-----	Bed with 203376
202258	17818	" Hinge Connection (2)
200570E	17818	" " " Screw (4)
54897	17812	" Oil Cup (3)
223852	17813	" Slide (back)
223811	17813	" " " Stop
223812	17813	" " " Spring
223853	17813	" " (front), for use with Throat Plates, in gauges from 1/32 to 1/2 inch
224043	17813	Bed Slide (front), for use with Throat Plates, in gauges from 17/32 to 1 inch
224044	17813	Bed Slide (front), for use with Throat Plates, in gauges from 1-1/32 to 1-23/32 inch

No.	Plate	Name
203470	17803	Bobbin
*248459	-----	" Case (chromium plated)
203648	17803	" " Latch
*202056	-----	" " " Pin
203473	17803	" " " Plunger
203474	17803	" " " Spring
241674	17803	" " Oiling Felt
241675	17803	" " " Retainer
350405C	17803	" " " " " Screw
248404	17804	" " Opener
224005	17804	" " " Lever with 201349C, 201542C and 203101
201349C	17804	Bobbin Case Opener Lever Driving Screw Stud
201542C	17804	Bobbin Case Opener Lever Driving Screw Stud Nut
203101	17804	Bobbin Case Opener Lever Driving Screw Stud Oil Packing (wick)
265088	17804	Bobbin Case Opener Lever Hinge Stud with 202277
202277	17804	Bobbin Case Opener Lever Hinge Stud Oil Packing (wick)
201246C	17804	Bobbin Case Opener Lever Hinge Stud Set Screw
248405	17804	Bobbin Case Opener Lever Link
200118D	17804	" " " Screw
236083	17803	" " Tension Spring
201016F	17803	" " " " Regulating Screw
200594C	17803	Bobbin Case Tension Spring Screw
203216	17803	" " Washer (cloth)
248460	17803	Bobbin Case complete, Nos. 200594C, 201016F, 202056, 203216, 203473, 203474, 203648, 236083, 241674, 241675, 248459 and two 350405C
202274	17813	Face Plate
202135	17813	" " Position Pin
200462H	17813	" " Thumb Screw
248406	17814	Feed Bar with 200336E and 201535E
248407	17814	" " 248406 with 200040C, 224052 and 225837
350393C	17814	Feed Bar Hinge Screw (driving)
201518E	17814	" " " " Nut
236401	17820	" Dog, for 236402
236403	17820	" " " 236405
236477	17820	" " " 236485
211669	17820	" " " 236427
211674	17820	" " " 236430
211679	17820	" " " 236433
211685	17821	" " " 236436
236439	17821	" " " 236441
211693	17821	" " " 236444
211698	17821	" " " 236450
236452	17821	" " " 236454
200106E	17820	" " Screw (2)

From the Library of: Diamond Needle Corp.

No.	Plate	Name
200336E	17814	Feed Dog Support Screw
201535E	17814	" " " " Nut
248409	17812	" Driving Crank (eccentric end) with 248410 and 248411
248408	17814	Feed Driving Crank (rock shaft end) with 200030H
248410	17812	Feed Driving Crank Oiling Felt
248411	17812	" " " " " Staple
248412	17814	" " " Oil Leader (brass)
200030H	17814	" " " Pinch Screw
248413	17812	" " Eccentric
248414	17812	" " " Adjusting Disc
248415	17812	" " " " " Spring
248416	17812	Feed Driving Eccentric Adjusting Disc Spring Collar with two 200382C
200382C	17812	Feed Driving Eccentric Adjusting Disc Spring Collar Set Screw
248417	17812	Feed Driving Eccentric Friction Glb
200350H	17812	" " " " " Adjusting Screw
200369D	17812	Feed Driving Eccentric Friction Glb Adjusting Screw Set Screw (2)
248471	17812	Feed Driving Eccentric Friction Glb Adjusting Screw Set Screw Packing (fibre)
248418	17812	Feed Driving Flange with 200382C, 201220C, two each 200350H, 200369D and 248471
201220C	17812	Feed Driving Flange Position Screw
200382C	17812	" " " Set Screw
248502	17814	" " Rock Shaft
248503	17814	" " " " 248502 with 201518E, 248407 and 350393C
248420	17814	Feed Driving Rock Shaft Bushing (left) (split)
200347C	17814	Feed Driving Rock Shaft Bushing (left) Pinch Screw
201007C	17814	Feed Driving Rock Shaft Bushing (left) Pinch Screw Set Screw
202355	17814	Feed Driving Rock Shaft Bushing (left) Pinch Screw Set Screw (brass)
248421	17814	Feed Driving Rock Shaft Bushing (right) (split)
200327C	17814	Feed Driving Rock Shaft Bushing (right) Pinch Screw
200347C	17814	Feed Driving Rock Shaft Bushing (right) Pinch Screw Set Screw
202355	17814	Feed Driving Rock Shaft Bushing (right) Pinch Screw Set Screw Pack- ing (brass)
202625	17814	Feed Driving Rock Shaft Stop Collar with two 200383C (2)
200383C	17814	Feed Driving Rock Shaft Stop Collar Set Screw

No.	Plate	Name
248449	17818	Feed Indicating Disc with 200958C
200958C	17818	" " " Set Screw
224154	17812	" Lifting Eccentric with 201220C
224052	17814	" " " Fork with 200173D and 223655
200040C	17814	Feed Lifting Eccentric Fork Screw
225837	17814	" " " " " Washer
223655	17814	" " " Oiling Felt
200173D	17814	" " " " " Screw
201220C	17812	Feed Lifting Eccentric Set Screw
248422	17812	" Regulating Stud
248423	17812	" " " Cotter Pin
248424	17812	" " " Socket
248425	17812	" " " Spring
248447	17812	Feed Regulating Stud complete, Nos. 248422 to 248425
*248444	17803	Hook (sewing)
248445	17803	" 248444 with 203525, 224025, two each 200590H and 201253F
248463	17803	Hook and Hobbin Case complete, Nos. 248445 and 248460
249365	17804	Hook Ball Bearing
350394E	17804	" " " Adjusting Screw
200403C	17804	" " " " " Set Screw
204479	17804	Hook Ball Bearing Adjusting Screw Set Screw Packing (brass)
248429	17804	Hook Ball Bearing Washer (steel)
248430	17804	" " " " (felt)
223867	17812	" Driving Gear (spiral) with 200362C and 201222C (2)
201222C	17812	Hook Driving Gear Position Screw
200362C	17812	" " " Set Screw
248431	17804	" " Pinion (spiral) with two 200382C
200382C	17804	Hook Driving Pinion Set Screw
248432	17812	" " Shaft
249440	17812	" " " Ball Bearing
*236695	17812	" " " " " Collar with 200378C and 201220C
236696	17812	Hook Driving Shaft Ball Bearing Collar 236695 with 249440
201220C	17812	Hook Driving Shaft Ball Bearing Collar Position Screw
200378C	17812	Hook Driving Shaft Ball Bearing Collar Set Screw
*240056	17812	Hook Driving Shaft Ball Bearing Re- taining Washer
*240058	17812	Hook Driving Shaft Bushing (back)
236697	17812	Hook Driving Shaft Bushing (back, ball bearing) complete, Nos. 236696, 240056 and 240058
200335C	17812	Hook Driving Shaft Bushing (back) Set Screw

No.	Plate	Name
224112	17812	Hook Driving Shaft Connection Belt Pulley with 202253 and two 201254C
201254C	17812	Hook Driving Shaft Connection Belt Pulley Set Screw
202253	17812	Hook Driving Shaft Connection Belt Pulley Spring Flange
203525	17803	Hook Gib
201253F	17803	" " Screw
248433	17805	" Saddle (left) with 200009E and 201246C
248434	17804	Hook Saddle (right) with 200009E and 201246C
223680	17812	Hook Saddle Bearing (left)
200327C	17812	" " " " Set Screw
223681	17812	" " " (right)
200335C	17812	" " " " Set Screw
248435	17804	" " Oil Pad (felt)
200009E	17804	" " Pinch Screw
200006E	17804	" " Screw (2)
225585	17804	" " Washer (2)
248438	17805	Hook Saddle (left) complete, Nos. 200118D, 200403C, 204479, 224005, 248404, 248405, 248430, 248431, 248433, 248463, 265088, 350394E, two each 248429, 249365 and four 248435
248439	17804	Hook Saddle (right) complete, Nos. 200118D, 200403C, 204479, 224005, 248404, 248405, 248430, 248431, 248434, 248463, 265088, 350394F, two each 248429, 249365 and four 248435
224025	17803	Hook Washer
200590H	17803	" " Screw
240067	17813	Knee Lifter Connection Lever
200262H	17813	" " " " Hinge Screw
223684	17813	Knee Lifter Connection Lever Lifting Rod with 202302
202302	17813	Knee Lifter Connection Lever Lifting Rod Cotter Pin
206628	17813	Knee Lifter Connection Lever Lifting Rod Spring
227227	17813	Knee Lifter Connection Lever Lifting Rod Spring Collar with 200113F
200113F	17813	Knee Lifter Connection Lever Lifting Rod Spring Collar Set Screw
240068	17813	Knee Lifter Lifting Lever
200262H	17813	" " " " Hinge Screw
223686	17816	Needle Bar
235871	17816	" " Bushing (lower)
235872	17816	" " " (upper)
200352C	17816	" " " Set Screw (2)
202552	17816	" " Connecting Link
264718	17816	" " " " Oil Guard
201183D	17816	" " " " " Screw

No.	Plate	Name
202333	17816	Needle Bar Connecting Link Stud with 202254
202254	17816	Needle Bar Connecting Link Stud Oil Packing (wick)
200374C	17816	Needle Bar Connecting Link Stud Set Screw
200383C	17816	Needle Bar Connecting Link Stud Set Screw
264714	17816	Needle Bar Connecting Stud with 200072C and 202277
202277	17816	Needle Bar Connecting Stud Oil Packing (wick)
200072C	17816	Needle Bar Connecting Stud Pinch Screw
202692	17816	" " Crank with 200335C, 200374C, 200383C, 200428C and 202333
248448	17816	Needle Bar Crank 202692 with 202400, 202552, 223881, 249398 and 264714
203172	17816	Needle Bar Crank Friction Washer
200428C	17816	" " " Position Screw
200335C	17816	" " " Set Screw
236650	17815	Needle Holder, needles 3/32 in. apart and must be set diagonally in gauges 1/32, 3/64 and 1/16 in., with 201030F and two 200141F
223878	17815	Needle Holder, in gauges from 3/32 to 15/32 in., in steps of 1/32 in., with 201030F and two 200141F
223879	17815	Needle Holder, in gauges from 17/32 to 23/32 in., in steps of 1/32 in., with 201030F and two 200141F
223863	17815	Needle Holder, in gauges from 1/2 to 3/4 in., in steps of 1/32 in., with 201030F and two 200141F
223880	17815	Needle Holder, in gauges from 25/32 to 1-1/2 in., in steps of 1/32 in., with 201030F and two 200141F
201030F	17815	Needle Holder Screw
200141F	17815	" Set Screw
208566	17816	Presser Bar with 200074F
207072	17816	" " Bushing (2)
200352C	17816	" " " Set Screw (2)
202554	17816	" " Lifter
200653C	17816	" " " Hinge Screw
244006	17816	" " Lifting Releasing Lever Bracket
200260D	17816	Presser Bar Lifting Releasing Lever Bracket Guide Screw
206608	17816	Presser Bar Lifting Releasing Lever Bracket Spring
235901	17816	Presser Bar Position Guide with 200054E
200054E	17816	Presser Bar Position Guide Pinch Screw
207965	17813	" " Spring (flat)
210949	17816	" " " Bracket with 200086C
200086C	17816	" " " " Pinch Screw

No.	Plate	Name
201410F	17813	Presser Bar Spring Regulating Thumb Screw
200948F	17813	Presser Bar Spring Support Screw
229092	17824	" Foot, 50 needle hole, needles 3/32 in. apart, in gauges 1/32, 3/64 and 1/16 inch
229102	17824	Presser Foot, 46 needle hole, in gauges from 3/32 to 7/32 in., in steps of 1/32 inch
229103	17824	Presser Foot, 46 needle hole, in gauges 1/4, 9/32 and 5/16 inch
229104	17824	Presser Foot, 46 needle hole, in gauges from 11/32 to 1/2 in., in steps of 1/32 inch
229105	17824	Presser Foot, 46 needle hole, in gauges 17/32 and 9/16 inch
229106	17824	Presser Foot, 46 needle hole, in gauges 19/32, 5/8, 21/32 and 11/16 inch
229107	17824	Presser Foot, 46 needle hole, in gauges 23/32 and 3/4 inch
229108	17824	Presser Foot, 46 needle hole, in gauges from 25/32 to 1 in., in steps of 1/32 inch
229110	17824	Presser Foot, 46 needle hole, in gauges from 1-1/32 to 1-1/2 in., in steps of 1/32 inch
200074F	17816	Presser Foot Screw
223881	17816	Take-up Lever
249398	17816	" " Driving Stud with 202277
202277	17816	" " " " Oil Packing (wick)
202400	17816	Take-up Lever Hinge Stud with 202423
202423	17816	" " " " Oil Packing (wick)
200383C	17816	Take-up Lever Hinge Stud Set Screw
202401	17816	" " Oiling Felt
200132E	17816	" " " " Screw
263090	17816	" " " Wick
248504	17816	" " " " 263090 with 248505
200109E	17816	Take-up Lever Oiling Wick Screw
201535E	17816	" " " " " Nut
*248505	17816	" " " " " Wire
223702	17819	Tension Bracket with two each 201224B and 236060
200159F	17819	Tension Bracket Screw
223705	17819	Tension Bracket complete, Nos. 200978H, 201199F, 223702, 223703, 223706, 237174 two each 13710, 200309E, 204271, 223704, three 201572H and four 244048
244048	17819	Tension Disc
236060	17819	" " Position Pin
223703	17819	" Release Lever
235072	17816	" " " Rod
200309E	17819	" " " Screw

No.	Plate	Name
223704	17819	Tension Release Plunger
204271	17819	" " Washer
13710	17819	" Spring
201224B	17819	" Stud
201572H	17819	" Thumb Nut
223706	17819	Thread Controller Disc
200978H	17819	" " " Screw
237174	17819	" " Spring
241360	17819	" " " Stop
200132E	17819	" " " " Screw
201199F	17819	" " Stud with 204925
200061C	17819	" " Set Screw
201572H	17819	" " Thumb Nut
204925	17819	" " Washer
224028	17817	" Guide
236007	17819	" " (lower)
200582H	17819	" " " Screw (2)
202741	17819	" " (upper)
200397H	17819	" " " Set Screw
240034	17819	" Retainer (2)
200366H	17819	" " Set Screw (2)
236402	17820	Throat Plate, 50 needle hole, needles 3/32 in. apart, for needle sizes 14 and 15, in gauges 1/32, 3/64 and 1/16 in., for 236401
236405	17820	Throat Plate, 50 needle hole, for needle sizes 14 and 15, in gauges 3/32, 1/8 and 5/32 in., for 236403
236485	17820	Throat Plate, 50 needle hole, for needle sizes 14 and 15, in gauges from 3/16 to 11/32 in., in steps of 1/32 in., for 236477
236427	17820	Throat Plate, 50 needle hole, for needle sizes 14 and 15, in gauges 3/8, 13/32, 7/16, 15/32 and 1/2 in., for 211669
236430	17820	Throat Plate, 50 needle hole, for needle sizes 14 and 15, in gauges 1/2, 9/32, 9/16, 9/32 and 5/8 inch, for 211674
236433	17820	Throat Plate, 50 needle hole, for needle sizes 14 and 15, in gauges from 9/16 to 23/32 in., in steps of 1/32 in., for 211679
236436	17821	Throat Plate, 50 needle hole, for needle sizes 14 and 15, in gauges from 23/32 to 7/8 in., in steps of 1/32 in., for 211685
236441	17821	Throat Plate, 50 needle hole, for needle sizes 14 and 15, in gauges from 13/16 to 1-1/8 in., in steps of 1/32 inch, for 236439
236444	17821	Throat Plate, 50 needle hole, for needle sizes 14 and 15, in gauges from 1 to 1-3/16 in., in steps of 1/32 in., for 211693
236450	17821	Throat Plate, 50 needle hole, for needle sizes 14 and 15, in gauges 1-1/4, 1-9/32 and 1-5/16 in., for 211698

Copyright © 1980 by Diamond Needle Corp.

No.	Plate	Name
236454	17821	Throat Plate, 50 needle hole, for needle sizes 14 and 15, in gauges from 1-3/8 to 1-1/2 in., in steps of 1/32 in., for 236452
200161D	17820	Throat Plate Clamp Screw
203376	17820	" " Position Pin
691F	17820	" " Screw

SINGER Needles should be used
in **SINGER** Machines
These Needles and their Containers
are marked with the
Company's Trade Mark "SIMANCO."

Needles in Containers marked
"FOR SINGER MACHINES"
are NOT **SINGER** made needles.

ACCESSORIES

No.	Plate	Name
200157B	17813	Attachment Screw
203470	17803	Bobbin (10)
228476	13067	Screw Driver (Bobbin Case)
135x7	-----	Needles, twelve, size 14
224121	16644	Drip Pan, 20 in. long, with four 3/4 in. wire nails
41400	13067	Machine Rest Pin (wood)
120342	13067	Oiler (copper plated) with 120343
120343	13067	" Spout, 3-1/2 in. long
225498	13067	Screw Driver (7-1/4 in. long)
225554	13067	Wrench (steel)

BOBBIN WINDER

(SWINGING AUTOMATIC, RIGHT HAND)

FOR 5/16 INCH ROUND BELT DRIVE

259428	18312	Brake (leather)
259429	18312	" Clamp
200113F	18312	" " Screw
225453	18312	Frame with 202277 and 259660
225454	18312	" Hinge Pin
202277	18312	" Oil Packing (wick)
259660	18312	" " Well Washer
225455	18312	" Spring
225456	18312	" " Plunger
225368	18312	Pulley with 200380C
200380C	18312	" Set Screw
225381	18312	Spindle
225444	18312	Stop Latch
200056E	18312	" " Screw
225458	18312	" " Thumb Lever
225459	18312	" " " Hinge Stud
225459	18312	" " " Joint Stud
202478	18312	" " Trip Lever
200299H	18312	" " " Hinge Screw
225461	18312	Tension Bracket with 201499H
200082D	18312	" " Screw
228026	18312	" " " Washer
2102	18312	" Disc
13710	18312	" Spring
201499H	18312	" Stud
201572H	18312	" " Thumb Nut
225462	18312	Bobbin Winder Tension Bracket complete, Nos: 13710, 201572H, 225461 and two 2102
259430	18312	Bobbin Winder and Tension Bracket Base

ACCESSORIES

No.	Plate	Name
259431	18312	Universal Bobbin Winder complete, Nos. 200056E, 200082D, 200113F, 200299H, 202478, 225368, 225391, 225444, 225453 to 225456, 225458, 225462, 228026, 259428 to 259430 two each 225459 and wood screws 3/4 in., No. 12, R.H.B.

KNEE LIFTER

228359	16643	Rock Lever with two 350231C
228486	16643	" " Bracket with 200347C and three wood screws 7/8 in., No. 12
228361	16643	Rock Lever Bracket 228486 with 228359, 228363, 228367, 228386 and 228455
228362	16643	Rock Lever Extension with 200529C
350231C	16643	" " " Set Screw
228363	16643	" " Hinge Pin
228364	16643	" " Knee Plate with 350231C
228388	16643	" " " " Arm
350231C	16643	" " " " Set Screw
350231C	16643	" " " " Set Screw
228455	16643	" " Position Spring
228365	16643	" " Rod
200529C	16643	" " " Set Screw
228386	16643	" " Spring
228367	16643	" " Stop Stud
200347C	16643	" " " " Set Screw
228368	16643	Knee Lifter complete, Nos. 228361, 228362, 228364, 228365 and 228388

THREAD UNWINDER

FOR THREE SPOOLS

225259	16257	Spool Rest (for one spool) (flat) with 201018C
225257	16257	Spool Rest (for two spools) (flat) with 201018C
150203	16257	Spool Rest Cushion (felt)
225388	16257	" " Rod
200383C	16257	" " " Set Screw
201018C	16257	" " " Set Screw
259658	16257	" Stand with 200383C
225391	16257	Thread Guide
201696H	16257	" " Lock Nut
225326	16257	" " Position Cup
225324	16257	" Rod with 208AL and 225322
208AL	16257	" " " Screw
225322	16257	" " " Washer

ACCESSORIES

No.	Plate	Name
259143	16257	Thread Unwinder (for three spools) complete, Nos. 201696H, 225257, 225259, 225324, 225326, 225388, 259658, three each 150203, 225391 and wood screws 7/8 in., No. 12

ATTACHMENT SLIDE PLATES

224144	17813	Attachment Slide Plate with 213479 and 236061
224146	17813	Attachment Slide Plate with 213479 and 236061, for use with depressed Throat Plates

BOBBIN WINDER

(SWINGING AUTOMATIC, RIGHT HAND)

FOR "V" BELT DRIVE

259428	18312	Brake (leather)
259429	18312	" Clamp
200113F	18312	" " Screw
225453	18312	Frame with 202277 and 259660
225454	18312	" Hinge Pin
202277	18312	" Oil Packing (wick)
259660	18312	" " Well Washer
225455	18312	" Spring
225456	18312	" " Plunger
259461	18312	Pulley with 200380C
200380C	18312	" Set Screw
225381	18312	Spindle
225444	18312	Stop Latch
200056E	18312	" " Screw
225458	18312	" " Thumb Lever
225459	18312	" " " " Hinge Stud
202478	18312	" " " " Joint Stud
200299H	18312	" " Trip Lever
225461	18312	" " " " Hinge Screw
200082D	18312	Tension Bracket with 201499H
228026	18312	" " " Screw
2102	18312	" " " Washer
13710	18312	" Disc
201499H	18312	" Spring
201572H	18312	" Stud
225462	18312	" " Thumb Nut
259662	18312	Bobbin Winder Tension Bracket complete, Nos. 13710, 201572H, 225461 and two 2102
259662	18312	Bobbin Winder and Tension Bracket Base

BOBBIN WINDER

No.	Plate	Name
259462	18312	Universal Bobbin Winder complete, Nos. 200056E, 200082D, 200113E, 200299H, 202478, 225381, 225444, 225453 to 225456, 225458, 225462, 228026, 259428, 259429, 259461, 259662, two each 225459 and wood screws 3/4 in., No. 12, R.H.B.

FEED DOGS

No.	Plate	Name
211669	17820	Feed Dog, for 236427 to 236429
211674	17820	" " " 236430 to 236432
211679	17820	" " " 236433 to 236435
211684	17821	" " " 236436 to 236438
211685	17821	" " " 236436 to 236438
211693	17821	" " " 236444 to 236446
211694	17821	" " " 236444 to 236446
211698	17821	" " " 236450 and 236451
211739	17821	" " " 236462 and 236472
212571	17822	" " " 236408 to 236410
236401	17820	" " " 236402
236403	17820	" " " 236404 to 236406
236411	17822	" " " 236412 to 236414
236415	17822	" " " 236417, 236418 and 236465
236416	17822	" " " 236417, 236418 and 236465
236419	17822	" " " 236420 to 236422
236423	17822	" " " 236424 to 236426
236439	17821	" " " 236441 to 236443
236440	17821	" " " 236441 to 236443
236447	17822	" " " 236448 and 236449
236452	17821	" " " 236454 and 236455
236453	17821	" " " 236454 and 236455
236456	17823	" " " 236457
236458	17823	" " " 236459 to 236461
236464	17823	" " " 236463 and 236467
236466	17821	" " " 236462 and 236472
236469	17823	" " " 236468
236470	17822	" " " 236417, 236418 and 236465
236471	17823	" " " 236457
236477	17820	" " " 236485

NEEDLE HOLDERS

236650	17815	Needle Holder, needles 3/32 in. apart and must be set diagonally, in gauges 1/32, 3/64 and 1/16 in., with 201030F and two 200141F
--------	-------	---

NEEDLE HOLDERS

No.	Plate	Name
223878	17815	Needle Holder, in gauges from 3/32 to 15/32 in., in steps of 1/32 in., with 201030F and two 200141F
223879	17815	Needle Holder, in gauges from 17/32 to 23/32 in., in steps of 1/32 in., with 201030F and two 200141F
223863	17815	Needle Holder, in gauges from 1/2 to 3/4 in., in steps of 1/32 in., with 201030F and two 200141F
223680	17815	Needle Holder, in gauges from 25/32 to 1-1/2 in., in steps of 1/32 in., with 201030F and two 200141F

PRESSER FEET

229008	17824	Presser Foot, 50 needle hole, needles 3/32 in. apart, in gauges 1/32, 3/64 and 1/16 inch
229092	17824	Presser Foot, 50 needle hole, needles 3/32 in. apart, in gauges 1/32, 3/64 and 1/16 inch
229101	17824	Presser Foot, 50 needle hole, needles 3/32 in. apart, in gauges 1/32, 3/64 and 1/16 inch
229102	17824	Presser Foot, 46 needle hole, in gauges from 3/32 to 7/32 in., in steps of 1/32 inch
229103	17824	Presser Foot, 46 needle hole, in gauges 1/4, 9/32 and 5/16 inch
229104	17824	Presser Foot, 46 needle hole, in gauges from 11/32 to 1/2 in., in steps of 1/32 inch
229105	17824	Presser Foot, 46 needle hole, in gauges 17/32 and 9/16 inch
229106	17824	Presser Foot, 46 needle hole, in gauges 19/32, 5/8, 21/32 and 11/16 inch
229107	17824	Presser Foot, 46 needle hole, in gauges 23/32 and 3/4 inch
229108	17824	Presser Foot, 46 needle hole, in gauges from 25/32 to 1 in., in steps of 1/32 inch
229110	17824	Presser Foot, 46 needle hole, in gauges from 1-1/32 to 1-1/2 in., in steps of 1/32 inch
222226	17825	Presser Foot, 46 needle hole, in gauges 3/16, 7/32 and 1/4 inch

PRESSER FEET

No.	Plate	Name
229542	17825	Presser Foot, 46 needle hole, in gauges from 1/8 to 1/2 in., in steps of 1/32 in., with 200172H and 229541
229559	17824	Presser Foot, 50 needle hole, needles 3/32 in. apart, in gauges 1/32, 3/64 and 1/16 in., for filling
229572	17824	Presser Foot, 50 needle hole, needles 3/32 in. apart, in gauges 1/32, 3/64 and 1/16 inch
229575	17825	Presser Foot, 46 needle hole, in gauges from 3/32 to 1/4 in., in steps of 1/32 inch
229575	17825	Presser Foot, 46 needle hole, in gauges from 9/32 to 17/32 in., in steps of 1/32 inch
229577	17825	Presser Foot, 46 needle hole, in gauges from 9/16 to 23/32 in., in steps of 1/32 inch
229578	17825	Presser Foot, 46 needle hole, in gauges from 3/4 to 1-1/4 in., in steps of 1/32 inch
229604	17825	Presser Foot, 46 needle hole, in gauges from 1-9/32 to 1-3/4 in., in steps of 1/32 inch
224153	17826	Presser Foot, 50 needle hole, needles 3/32 in. apart, in gauges 1/32, 3/64 and 1/16 in., with 200175H and 224150, for attaching shoe vamps
224148	17826	Presser Foot, 46 needle hole, in gauges from 5/32 to 1/4 in., in steps of 1/32 in., with 200175H and 224150, for attaching shoe vamps
224150	17826	Presser Foot Spring Guide (right)
200175H	17826	" " " " Screw
230795	17826	" " Hinge Pin
202090	17828	" " " "
229013	17826	" " Plate, for 229012
229014	17826	" " " " 229015
229093	17826	" " " " 229094
229095	17826	" " " " 229096
229097	17826	" " " " 229098
229099	17827	" " " " 229100
229128	17827	" " " " 229129
229132	17827	" " " " 229133
229134	17827	" " " " 229135
229138	17827	" " " " 229139
229140	17827	" " " " 229141
229162	17827	" " " " 229163
229261	17827	" " " " 229262
229263	17828	" " " " 229264
229276	17828	" " " " 229278
229279	17828	" " " " 229280
229281	17828	" " " " 229282
229283	17828	" " " " 229284
229285	17828	" " " " 229286

PRESSER FEET

No.	Plate	Name
229720	17828	Presser Foot Plate, for 230697
230630	17828	" " " " 230631
229164	17828	" " " " 229165
223900	17829	" " " " 223901
223903	17829	" " " " 223904
229195	17829	" " " " 229197
229168	17829	" " " " 229169
229164	17829	" " " " 229168
229191	17829	" " " " 229192
229193	17829	" " " " 229194
229197	17830	" " " " 229199
229201	17830	" " " " 229202
229203	17830	" " " " 229204
229215	17830	" " " " 229216
229217	17830	" " " " 229217
229321	17830	" " " " 229322
229368	17830	" " " " 229369
229560	17830	" " " " 229561
229039	17831	" " " " 229040
229964	17831	" " " " 229965
229144	17831	" " " " 229145
229146	17831	" " " " 229147
229148	17831	" " " " 229149
229152	17831	" " " " 229153
226090	17831	" " " " Spring
202923	17826	" " Shank
202926	17826	" " " "
202930	17831	" " " "
229277	17828	" " " "
229541	17825	" " Spring Guide, in gauges from 1/8 to 1/2 in., in steps of 1/32 inch
200172H	17825	Presser Foot Spring Guide Screw
229012	17826	Presser Foot (hinged) complete, 46 needle hole, in gauges from 15/32 to 5/8 in., in steps of 1/32 in., Nos. 202926, 229013 and 230795
229015	17826	Presser Foot (hinged) complete, 46 needle hole, in gauges from 17/32 to 3/4 in., in steps of 1/32 in., Nos. 202923, 229093 and 230795
229094	17826	Presser Foot (hinged) complete, 46 needle hole, in gauges 1/8, 5/32 and 3/16 in., Nos. 202923, 229093 and 230795
229096	17826	Presser Foot (hinged) complete, 46 needle hole, in gauges 7/32, 1/4, 9/32 and 5/16 in., Nos. 202923, 229095 and 230795
229098	17826	Presser Foot (hinged) complete, 46 needle hole, in gauges 11/32, 3/8, 13/32 and 7/16 in., Nos. 202923, 229097 and 230795
229100	17827	Presser Foot (hinged) complete, 46 needle hole, in gauges from 15/32 to 5/8 in., in steps of 1/32 in., Nos. 202923, 229099 and 230795

PRESSER FEET

No.	Plate	Name
229129	17827	Presser Foot (hinged) complete, 50 needle hole, needles 3/32 in. apart, in gauges 1/32, 3/64 and 1/16 in., Nos. 202923, 229128 and 230795
229133	17827	Presser Foot (hinged) complete, 46 needle hole, in gauges 7/32, 1/4, 9/32 and 5/16 in., Nos. 202923, 229132 and 230795
229135	17827	Presser Foot (hinged) complete, 46 needle hole, in gauges 11/32, 3/8, 13/32 and 7/16 in., Nos. 202923, 229134 and 230795
229139	17827	Presser Foot (hinged) complete, 46 needle hole, in gauges from 15/32 to 5/8 in., in steps of 1/32 in., Nos. 202923, 229138 and 230795
229141	17827	Presser Foot (hinged) complete, 46 needle hole, in gauges 21/32, 11/16, 23/32 and 3/4 in., Nos. 202923, 229140 and 230795
229163	17827	Presser Foot (hinged) complete, 50 needle hole, in gauges 3/32, 1/8, 5/32 and 3/16 in., Nos. 202923, 229162 and 230795
229262	17827	Presser Foot (hinged) complete, 46 needle hole, in gauges from 3/16 to 3/8 in., in steps of 1/32 in., Nos. 202090, 202923 and 229261
229264	17828	Presser Foot (hinged) complete, 46 needle hole, in gauges 13/32, 7/16, 15/32 and 1/2 in., Nos. 202090, 202923 and 229263
229278	17828	Presser Foot (hinged) complete, 46 needle hole, in gauges 1/8, 5/32, 3/16 and 7/32 in., Nos. 202090, 229276 and 229277
229280	17828	Presser Foot (hinged) complete, 46 needle hole, in gauges 1/4, 9/32 and 5/16 in., Nos. 202090, 229277 and 229279
229282	17828	Presser Foot (hinged) complete, 46 needle hole, in gauges 11/32, 3/8, 13/32 and 7/16 in., Nos. 202090, 229277 and 229281
229284	17828	Presser Foot (hinged) complete, 46 needle hole, in gauges 1/2, 17/32 and 9/16 in., Nos. 202090, 229277 and 229283
229286	17828	Presser Foot (hinged) complete, 46 needle hole, in gauges 19/32, 5/8, 21/32 and 11/16 in., Nos. 202090, 229277 and 229285
230697	17828	Presser Foot (hinged) complete, 46 needle hole, in gauges from 3/16 to 1/2 in., in steps of 1/32 in., Nos. 202090, 202923 and 229280, for strip work

PRESSER FEET

No.	Plate	Name
230831	17828	Presser Foot (hinged) complete, 46 needle hole, in gauges from 3/4 to 7/8 in., in steps of 1/32 in., Nos. 202923, 230795 and 230830, for felling
229935	17829	Presser Foot (hinged) complete, 46 needle hole, in gauges 7/32, 1/4, 9/32 and 5/16 in., Nos. 202926, 229184 and 230795. Hinge pin set back 1/16 in. from regular, for felling
223901	17829	Presser Foot (hinged) complete, 50 needle hole, needles 3/32 in. apart, in 1/16 in. gauge, Nos. 202090, 202923 and 223900, for felling
223904	17829	Presser Foot (hinged) complete, 50 needle hole, in gauges 3/32, 1/6, 5/32 and 3/16 in., Nos. 202923, 223903 and 230795, for felling
229167	17829	Presser Foot (hinged) complete, 46 needle hole, in gauges 7/32, 1/4, 9/32 and 5/16 in., Nos. 202923, 229195 and 230795, for felling
229169	17829	Presser Foot (hinged) complete, 46 needle hole, in gauges 7/32, 1/4, 9/32 and 5/16 in., Nos. 202923, 229168 and 230795, for felling
229188	17829	Presser Foot (hinged) complete, 46 needle hole, in gauges 1/8, 5/32 and 3/16 in., Nos. 202926, 229164 and 230795. Hinge pin set back 1/16 in. from regular, for felling
229192	17829	Presser Foot (hinged) complete, 50 needle hole, needles 3/32 in. apart, in gauges 1/32, 3/64 and 1/16 in., Nos. 202923, 229191 and 230795, for felling
229194	17829	Presser Foot (hinged) complete, 46 needle hole, in gauges 3/32, 1/8, 5/32 and 3/16 in., Nos. 202923, 229193 and 230795, for felling
229198	17830	Presser Foot (hinged) complete, 46 needle hole, in gauges 11/32, 3/8, 13/32 and 7/16 in., Nos. 202923, 229197 and 230795, for felling
229202	17830	Presser Foot (hinged) complete, 46 needle hole, in gauges from 15/32 to 5/8 in., in steps of 1/32 in., Nos. 202923, 229201 and 230795, for felling
229204	17830	Presser Foot (hinged) complete, 46 needle hole, in gauges 21/32, 11/16, 23/32 and 3/4 in., Nos. 202923, 229203 and 230795, for felling
229216	17830	Presser Foot (hinged) complete, 46 needle hole, in gauges 7/32, 1/4, 9/32 and 5/16 in., Nos. 202926, 229215 and 230795. Hinge pin set back 1/16 in. from regular, for felling

No.	Plate	Name
229218	17830	Presser Foot (hinged) complete, 46 needle hole, in gauges 1/8, 5/32 and 3/16 in., Nos. 202930, 229217 and 230795. Hinge pin set back 1/8 in. from regular, for felling
229322	17830	Presser Foot (hinged) complete, 46 needle hole, in gauges 1/8, 5/32 and 3/16 in., Nos. 202926, 229321 and 230795. Hinge pin set back 1/16 in. from regular, for felling
229369	17830	Presser Foot (hinged) complete, 46 needle hole, in gauges 1/8, 5/32 and 3/16 in., Nos. 202923, 229368 and 230795, for felling
229561	17830	Presser Foot (hinged) complete, 46 needle hole, in gauges 11/32, 3/8, 13/32 and 7/16 in., Nos. 202926, 229560 and 230795. Hinge pin set back 1/16 in. from regular, for felling
229840	17831	Presser Foot (hinged) complete, 46 needle hole, in gauges 21/32, 11/16, 23/32 and 3/4 in., Nos. 202926, 229839 and 230795, for felling
229965	17831	Presser Foot (hinged) complete, 46 needle hole, in gauges from 13/32 to 5/8 in., in steps of 1/32 in., Nos. 202930, 229964 and 230795. Hinge pin set back 1/8 in. from regular, for felling
229145	17831	Presser Foot (hinged) complete, 46 needle hole, in gauges from 25/32 to 15/16 in., in steps of 1/32 in., Nos. 202923, 229144 and 230795
229147	17831	Presser Foot (hinged) complete, 46 needle hole, in gauges 31/32, 1, 1-1/32 and 1-1/16 in., Nos. 202923, 229146 and 230795
229149	17831	Presser Foot (hinged) complete, 46 needle hole, in gauges 1-3/32, 1-1/8, 1-5/32 and 1-3/16 in., Nos. 202923, 229148 and 230795
229153	17831	Presser Foot (hinged) complete, 46 needle hole, in gauges from 1-7/32 to 1-7/16 in., in steps of 1/32 in., Nos. 202923, 229152 and 230795
248510	17831	Presser Foot Plate
226080	17831	" " " Spring
248455	17831	" " Shank
248511	17831	Presser Foot (hinged) complete, 46 needle hole, in gauges 3/16, 7/32 and 1/4 in., Nos. 226080, 230795, 248455 and 248510
201031F	17831	Presser Foot Screw
248452	17831	" " Spring Guide
248508	17831	" " " "
248453	17831	" " " " Bracket with 201535E and 350422J

No.	Plate	Name
350422J	17831	Presser Foot Spring Guide Screw Stud
201535E	17831	" " " " " " Nut
248512	17831	Presser Foot (hinged) with Spring Guide complete, in gauges 3/16, 7/32 and 1/4 in., Nos. 201031F, 248452, 248453 and 248511
248507	17831	Presser Foot, 46 needle hole, in gauges 3/16, 7/32 and 1/4 inch
248509	17831	Presser Foot with Spring Guide complete, in gauges 3/16, 7/32 and 1/4 in., Nos. 201031F, 248453, 248507 and 248508

THROAT PLATES

236402	17820	Throat Plate, 50 needle hole, needle sizes 3/32 in. apart, for needle sizes 14 and 15, in gauges 1/32, 3/64 and 1/16 in., for 236401 Nos. 236404 to 236406, for 236403
236404	17820	Throat Plate, 53 needle hole, for needle sizes 12 and 13, in gauges 3/32, 1/8 and 5/32 inch
236405	17820	Throat Plate, 50 needle hole, for needle sizes 14 and 15, in gauges 3/32, 1/8 and 5/32 inch
236406	17820	Throat Plate, 46 needle hole, for needle sizes 16 and 18, in gauges 3/32 and 1/8 inch Nos. 236408 to 236410, for 212571
236408	17822	Throat Plate, 53 needle hole, for needle sizes 12 and 13, in gauges 3/16 and 7/32 inch
236409	17822	Throat Plate, 50 needle hole, for needle sizes 14 and 15, in gauges 3/16 and 7/32 inch
236410	17822	Throat Plate, 46 needle hole, for needle sizes 16 and 18, in gauges 5/32 and 3/16 inch Nos. 236412 to 236414, for 236411
236412	17822	Throat Plate, 53 needle hole, for needle sizes 12 and 13, in gauges 1/4 and 9/32 inch
236413	17822	Throat Plate, 50 needle hole, for needle sizes 14 and 15, in gauges 1/4 and 9/32 inch
236414	17822	Throat Plate, 46 needle hole, for needle sizes 16 and 18, in gauges 7/32 and 1/4 inch
236417	17822	Throat Plate, 50 needle hole, for needle sizes 14 and 15, in gauges from 7/32 to 7/16 in., in steps of 1/32 in., for 236415, 236416 and 236470

THROAT PLATES

No.	Plate	Name
236418	17822	Throat Plate, 40 needle hole, for needle size 20, in gauges from 1/4 to 7/16 in., in steps of 1/32 in., for 236415, 236416 and 236470 Nos. 236420 to 236422, for 236419
236420	17822	Throat Plate, 53 needle hole, for needle sizes 12 and 13, in gauges 9/32 and 5/16 inch
236421	17822	Throat Plate, 50 needle hole, for needle sizes 14 and 15, in gauges 9/32 and 5/16 inch
236422	17822	Throat Plate, 46 needle hole, for needle sizes 16 and 18, in gauges 9/32 and 5/16 inch Nos. 236424 to 236426, for 236423
236424	17822	Throat Plate, 53 needle hole, for needle sizes 12 and 13, in gauges 11/32 and 3/8 inch
236425	17822	Throat Plate, 50 needle hole, for needle sizes 14 and 15, in gauges 11/32 and 3/8 inch
236426	17822	Throat Plate, 46 needle hole, for needle sizes 16 and 18, in gauges 11/32 and 3/8 inch Nos. 236427 to 236429, for 211689
236427	17820	Throat Plate, 50 needle hole, for needle sizes 14 and 15, in gauges 3/8, 13/32, 7/16, 15/32 and 1/2 inch
236428	17820	Throat Plate, 46 needle hole, for needle sizes 16 and 18, in gauges 3/8, 13/32, 7/16, 15/32 and 1/2 inch
236429	17820	Throat Plate, 40 needle hole, for needle size 20, in gauges 13/32, 7/16, 15/32 and 1/2 inch Nos. 236430 to 236432, for 211674
236430	17820	Throat Plate, 50 needle hole, for needle sizes 14 and 15, in gauges 1/2, 17/32, 9/16, 9/32 and 5/8 inch
236431	17820	Throat Plate, 46 needle hole, for needle sizes 16 and 18, in gauges 1/2, 17/32, 9/16, 19/32 and 5/8 inch
236432	17820	Throat Plate, 40 needle hole, for needle size 20, in gauges 1/2, 17/32, 9/16, 19/32 and 5/8 inch Nos. 236433 to 236435, for 211679
236433	17820	Throat Plate, 50 needle hole, for needle sizes 14 and 15, in gauges from 9/16 to 23/32 in., in steps of 1/32 inch
236434	17820	Throat Plate, 46 needle hole, for needle sizes 16 and 18, in gauges from 9/16 to 23/32 in., in steps of 1/32 inch
236435	17820	Throat Plate, 40 needle hole, for needle size 20, in gauges from 9/16 to 23/32 in., in steps of 1/32 inch

THROAT PLATES

No.	Plate	Name
		Nos. 236436 to 236438, for 211684 and 211685
236436	17821	Throat Plate, 50 needle hole, for needle sizes 14 and 15, in gauges from 23/32 to 7/8 in., in steps of 1/32 inch
236437	17821	Throat Plate, 46 needle hole, for needle sizes 16 and 18, in gauges from 23/32 to 7/8 in., in steps of 1/32 inch
236438	17821	Throat Plate, 40 needle hole, for needle size 20, in gauges from 23/32 to 7/8 in., in steps of 1/32 inch Nos. 236441 to 236443, for 236439 and 236440
236441	17821	Throat Plate, 50 needle hole, for needle sizes 14 and 15, in gauges from 13/16 to 1-1/8 in., in steps of 1/32 inch
236442	17821	Throat Plate, 46 needle hole, for needle sizes 16 and 18, in gauges from 13/16 to 1-1/8 in., in steps of 1/32 inch
236443	17821	Throat Plate, 40 needle hole, for needle size 20, in gauges from 13/16 to 1-1/8 in., in steps of 1/32 inch Nos. 236444 to 236446, for 211693 and 211694
236444	17821	Throat Plate, 50 needle hole, for needle sizes 14 and 15, in gauges from 1 to 1-3/16 in., in steps of 1/32 inch
236445	17821	Throat Plate, 46 needle hole, for needle sizes 16 and 18, in gauges from 1 to 1-3/16 in., in steps of 1/32 inch
236446	17821	Throat Plate, 40 needle hole, for needle size 20, in gauges from 1 to 1-3/16 in., in steps of 1/32 inch
236448	17822	Throat Plate, 50 needle hole, for needle sizes 14 and 15, in gauges from 1-1/16 to 1-1/4 in., in steps of 1/32 inch
236449	17822	Throat Plate, 40 needle hole, for needle size 20, in gauges from 1-1/16 to 1-1/4 in., in steps of 1/32 inch
236450	17821	Throat Plate, 50 needle hole, for needle sizes 14 and 15, in gauges 1-1/4, 1-9/32 and 1-5/16 in., for 211698
236451	17821	Throat Plate, 46 needle hole, for needle sizes 16 and 18, in gauges 1-1/4, 1-9/32 and 1-5/16 in., for 211698
236454	17821	Throat Plate, 50 needle hole, for needle sizes 14 and 15, in gauges from 1-3/8 to 1-1/2 in., in steps of 1/32 in., for 236452 and 236453
236455	17821	Throat Plate, 46 needle hole, for needle sizes 16 and 18, in gauges from 1-3/8 to 1-1/2 in., in steps of 1/32 in., for 236452 and 236453
236457	17823	Throat Plate, 46 needle hole, for needle sizes 16 and 18, in gauges from 3/16 to 3/8 in., in steps of 1/32 in., for 236456 and 236471

THROAT PLATES

No.	Plate	Name
	Nos. 236459 to 236461, for 236458	
236459	17823	Throat Plate, 50 needle hole, for needle sizes 14 and 15, in gauges 3/16, 7/32, 1/4, 9/32 and 5/16 inch
236460	17823	Throat Plate, 46 needle hole, for needle sizes 16 and 18, in gauges 3/16, 7/32, 1/4, 9/32 and 5/16 inch
236461	17823	Throat Plate, 40 needle hole, for needle size 20, in gauges 3/16, 7/32, 1/4, 9/32 and 5/16 inch
236462	17821	Throat Plate, 40 needle hole, for needle size 20, in gauges from 1/4 to 1/2 in., in steps of 1/32 inch, for 211739 and 236466
236463	17823	Throat Plate, 50 needle hole, for needle sizes 14 and 15, in gauges 5/32 and 3/16 in., for 236464
236465	17822	Throat Plate, 46 needle hole, for needle sizes 16 and 18, in gauges from 1/4 to 7/16 in., in steps of 1/32 in., for 236415, 236416 and 236470
236467	17823	Throat Plate, 53 needle hole, for needle sizes 12 and 13, in gauges 1/8, 5/32 and 3/16 in., for 236464
236468	17823	Throat Plate, 50 needle hole, for needle sizes 14 and 15, in gauges from 1 to 1-3/16 in., in steps of 1/32 in., for 236469
236472	17821	Throat Plate, 50 needle hole, for needle sizes 14 and 15, in gauges from 1/4 to 1/2 in., in steps of 1/32 in., for 211739 and 236466
236485	17820	Throat Plate, 50 needle hole, for needle sizes 14 and 15, in gauges from 3/16 to 11/32 in., in steps of 1/32 in., for 236477

FOOT LIFTER

PARTS REQUIRED FOR CHANGING FROM

KNEE LIFTER TO FOOT LIFTER

223733	17813	Foot Lifter	Lifting	Lever	Extension
200082D	17813	"	"	"	" Screw
221145	17813	"	"	"	Spring
200835D	17813	"	"	"	" Stop Screw

FOOT LIFTER

No.	Plate	Name
227952	16862	Lever with 227954
227678	16862	" Chain, 48 in. long with 202784
227954	16862	" " Hook (lower)
202784	16862	" " " (upper)
225016	16862	" Hinge Pin
227953	16862	" Stand with two wood screws 1 in., No. 12
227955	16862	Foot Lifter Lever complete, Nos. 225016, 227678, 227952 and 227953

MISCELLANEOUS PARTS

USED IN CONJUNCTION WITH THREAD UNWINDER

Used in conjunction with Thread Unwinder

60913	16257	Spool Weight with 60914
60914	16257	" " Center Pin
225377	16257	" Wire, for small spools
27739	16257	Thread Cone (wood)
225390	16257	" " Holder

SINGER Needles should be used
in **SINGER** Machines
These Needles and their Containers
are marked with the
Company's Trade Mark "SIMANCO.***"

Needles in Containers marked
"FOR SINGER MACHINES"
are NOT **SINGER** made needles.

No.	Plate	Name
350107C	17817	Balance Wheel Position Screw, for 248456
350231C	16643	Knee Lifter Rock Lever Extension Set Screw, for 228359
350231C	16643	Knee Lifter Rock Lever Knee Plate Arm Set Screw, for 228359
350231C	16643	Knee Lifter Rock Lever Knee Plate Set Screw, for 228364
350393C	17814	Feed Bar Hinge Screw (driving), for 248503
350394E	17804	Hook Ball Bearing Adjusting Screw, for 248438 and 248439
350405C	17803	Bobbin Case Oiling Felt Retainer Screw, for 248460
350419H	17817	Balance Wheel Adjusting Screw
350422J	17831	Presser Foot Spring Guide Screw Stud, for 248453
350431E	17817	Arm Shaft Oil Packing Stop Screw, for 248440

13067 - 1/2

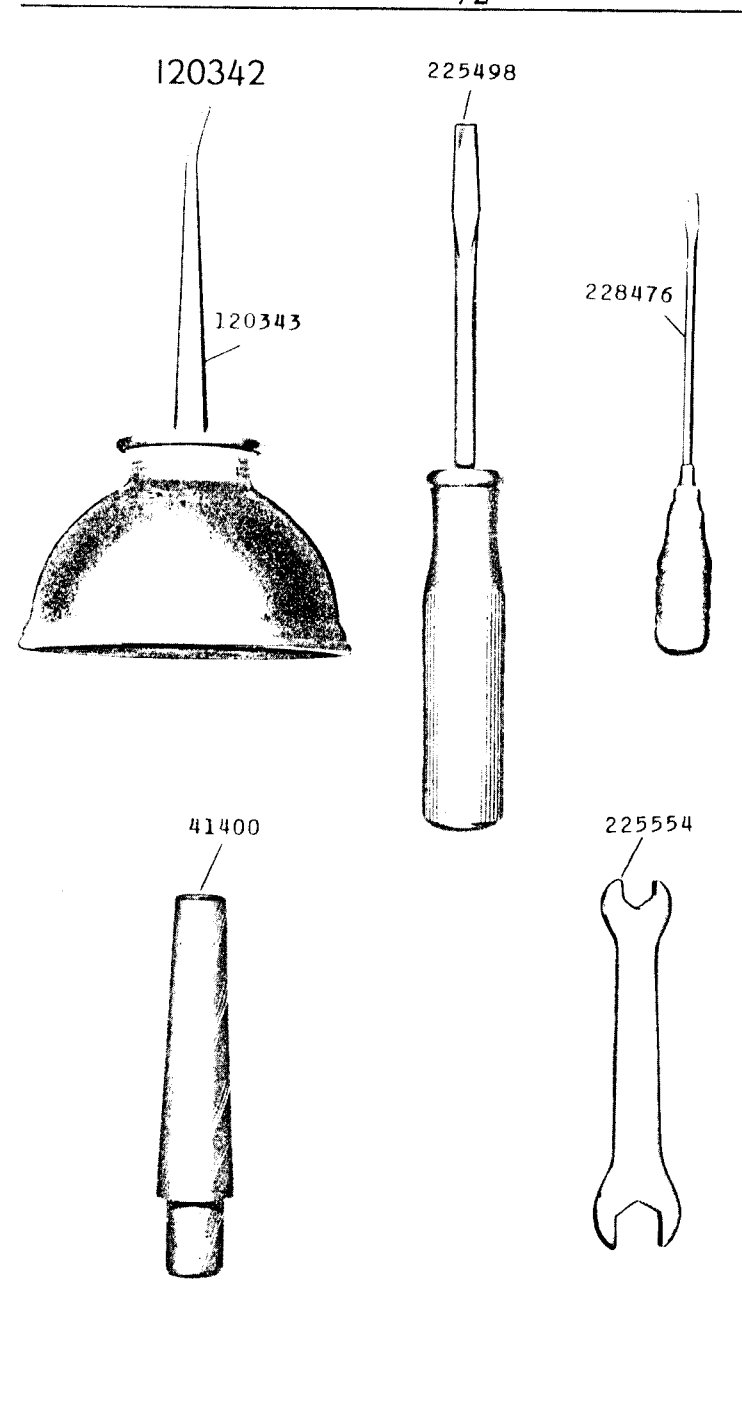

SINGER Needles should be used
in **SINGER** Machines
These Needles and their Containers
are marked with the
Company's Trade Mark "SIMANCO."

Needles in Containers marked
"FOR SINGER MACHINES"
are NOT **SINGER** made needles.

16644 - 1/3

224121

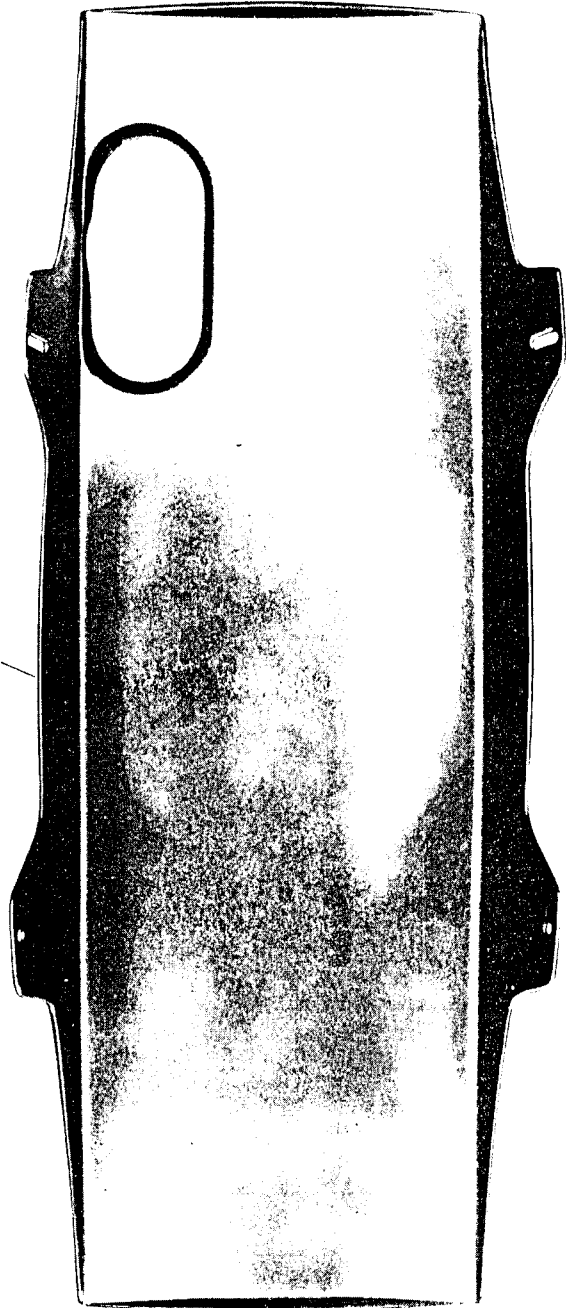

16862 - 1/3

202784

227955

227678-48"

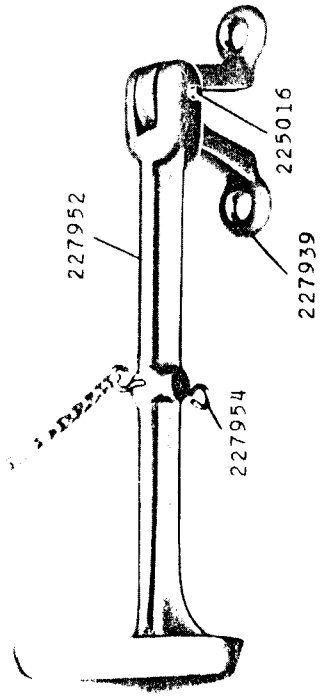
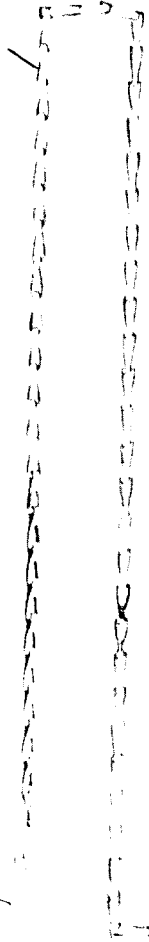

From the library of: Diamond Needle Corp

17803

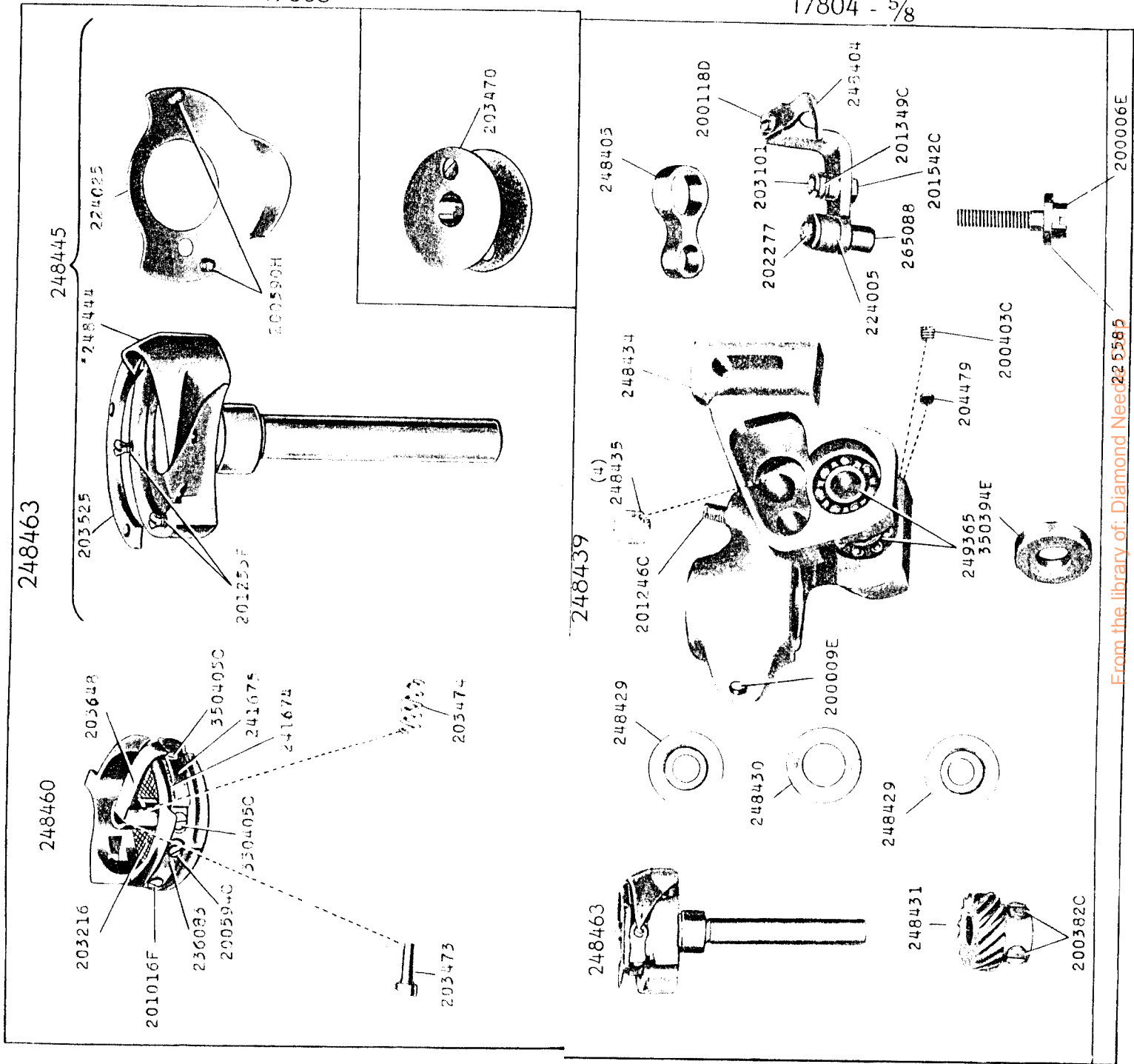

17804 - 5/8

From the library of: Diamond Need 22 5585

17805 - 5/8

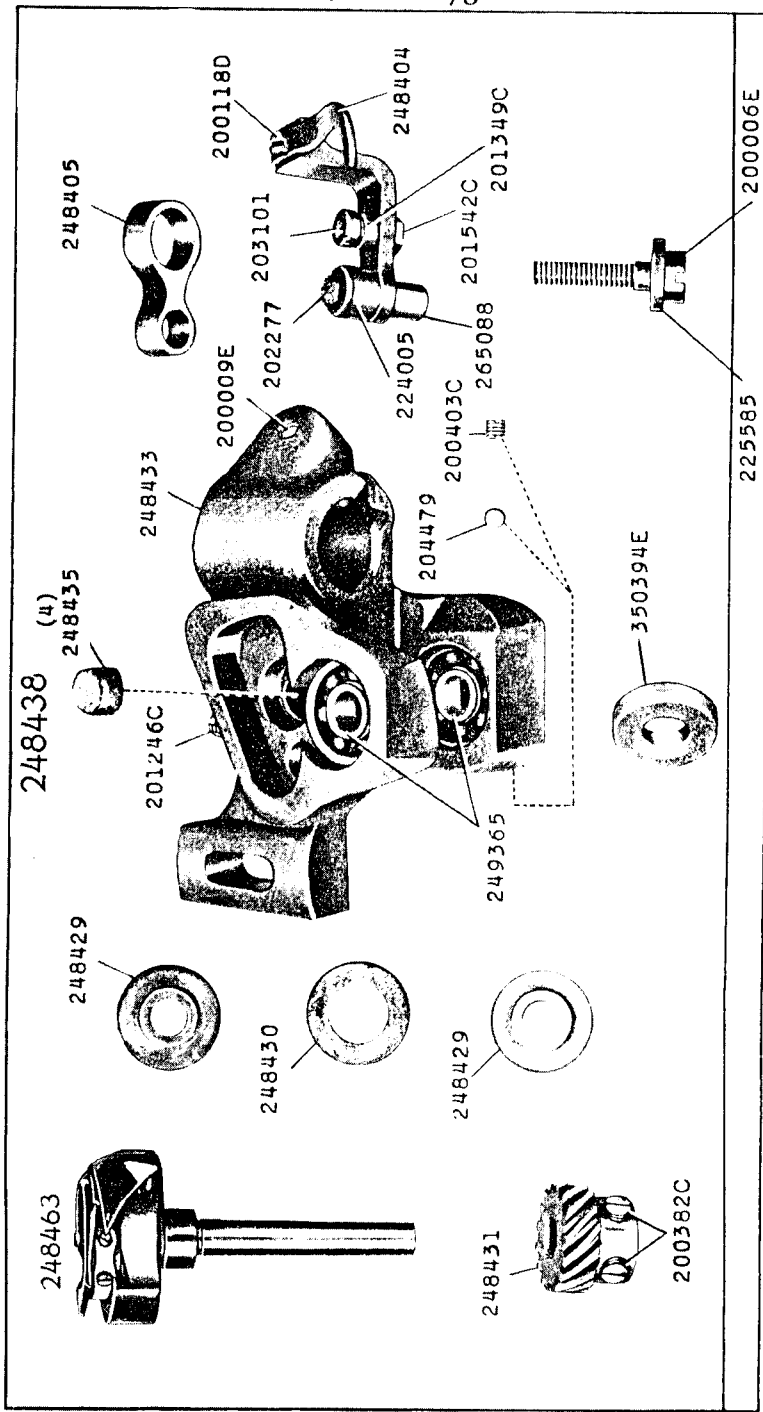

17812 - 3/8

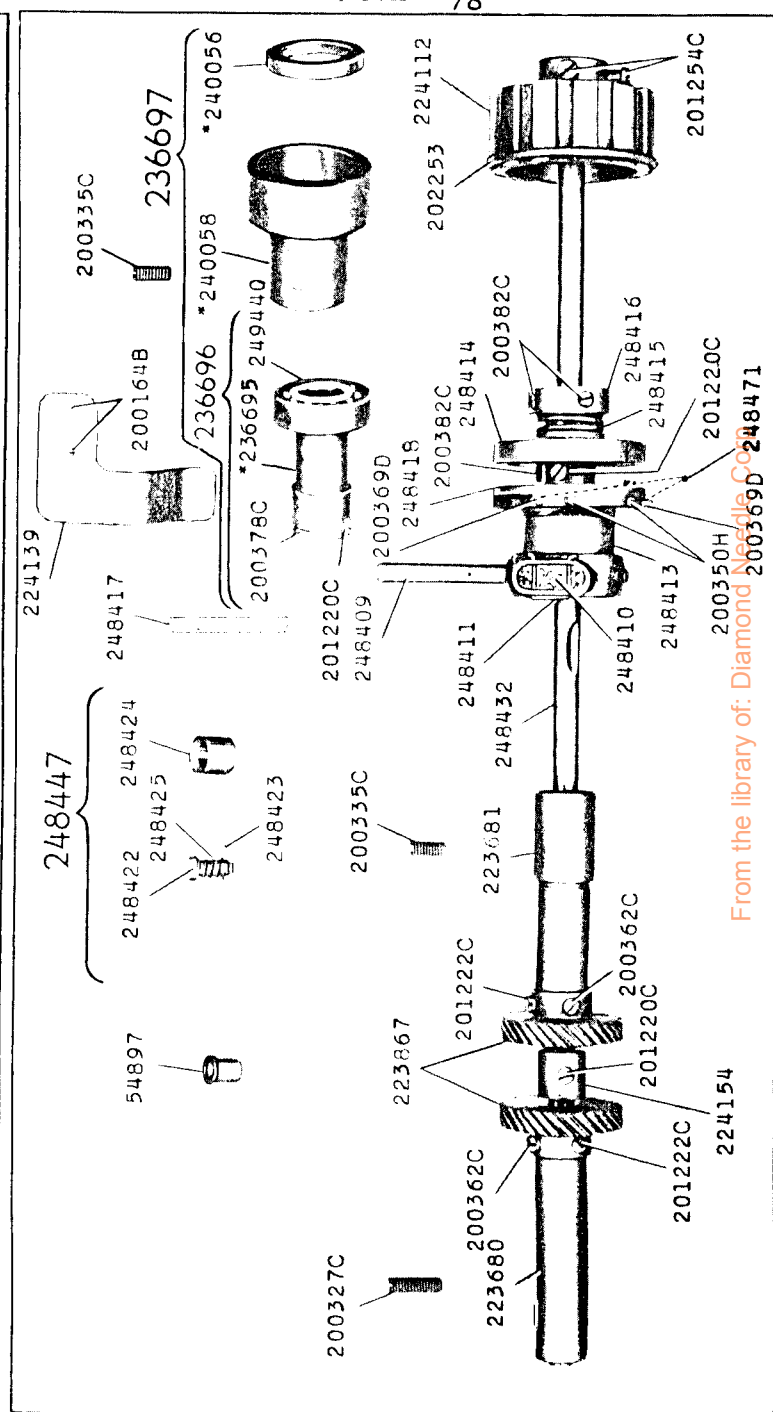

From the library of: Diamond Needle Co.

17813 - 1/3

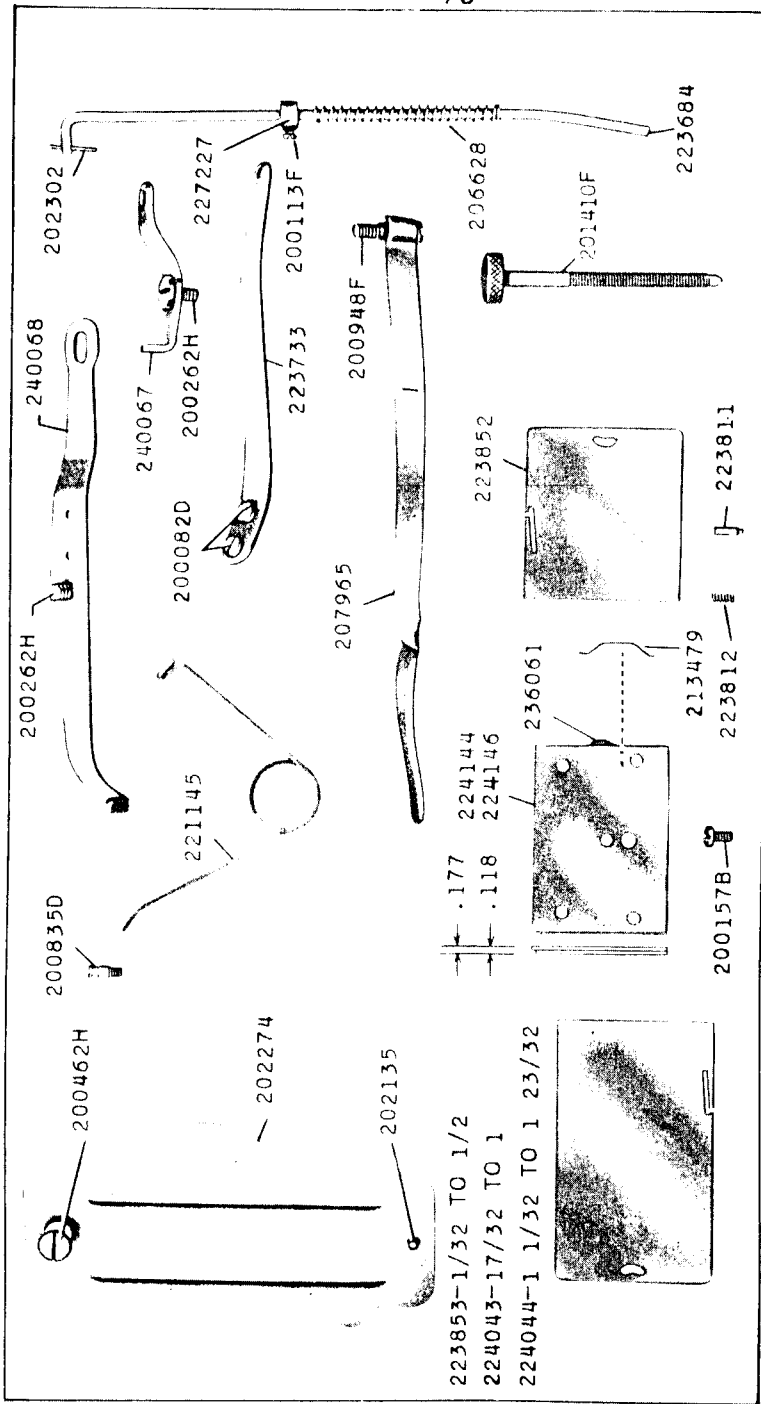

17814 - 3/8

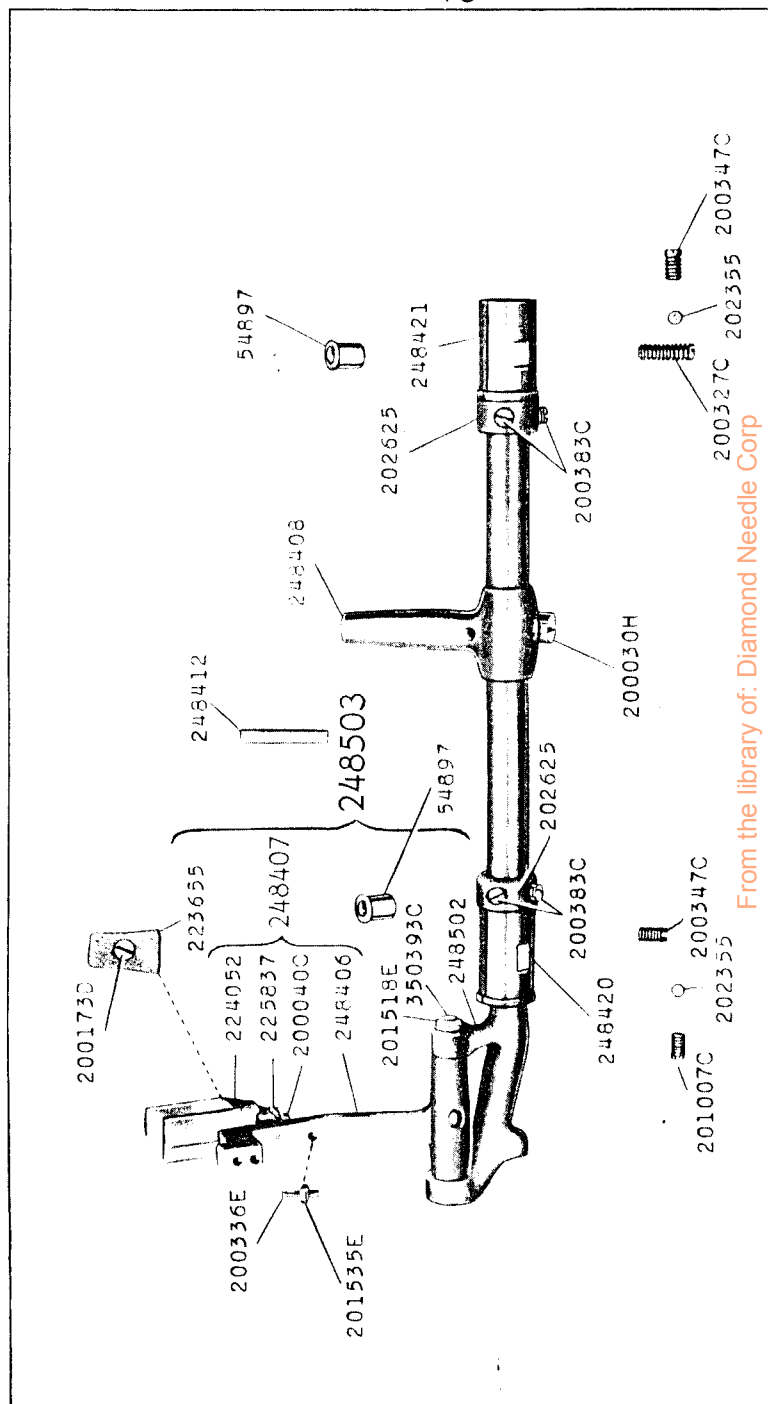

From the library of: Diamond Needle Corp

17815

223878-3/32" TO 15/32"
 223879-17/32" TO 23/32"
 223863-1/2" TO 3/4"
 IN STEPS OF 1/32"

236650
 1/32" 3/64" 1/16"
 3/32" APART

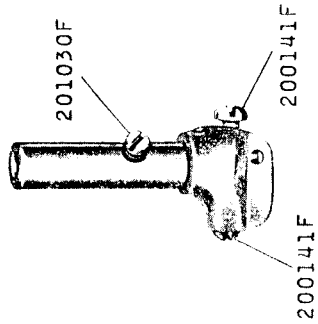
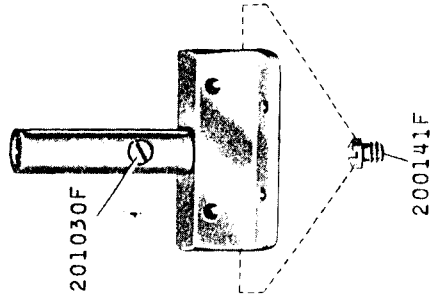
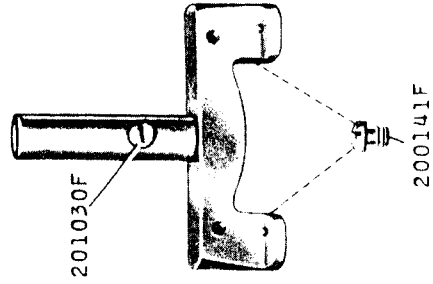

17816 - 3/8

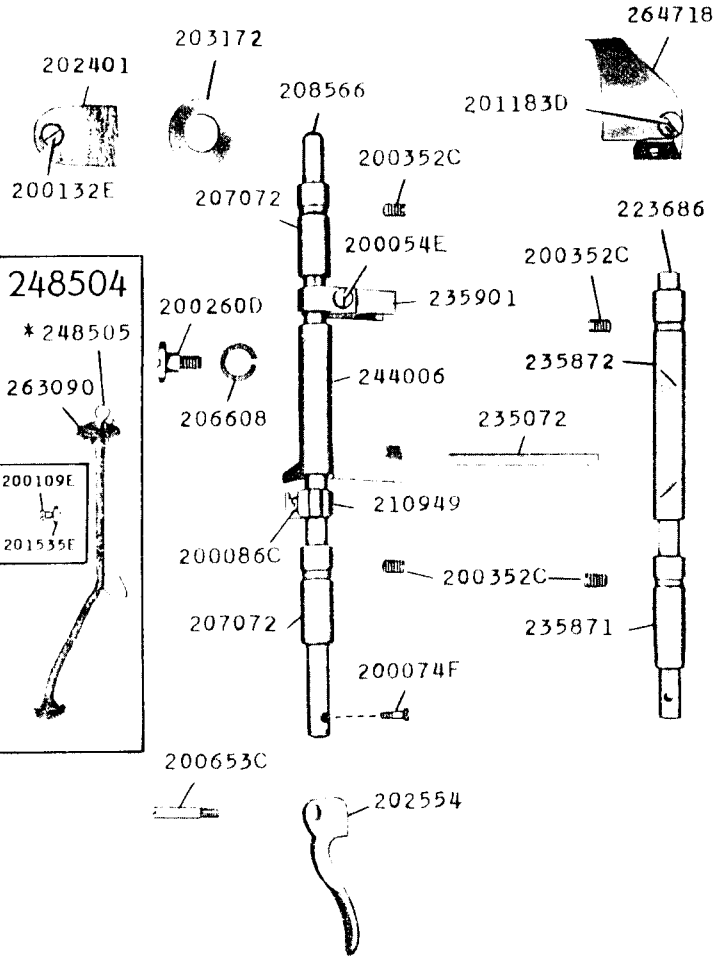
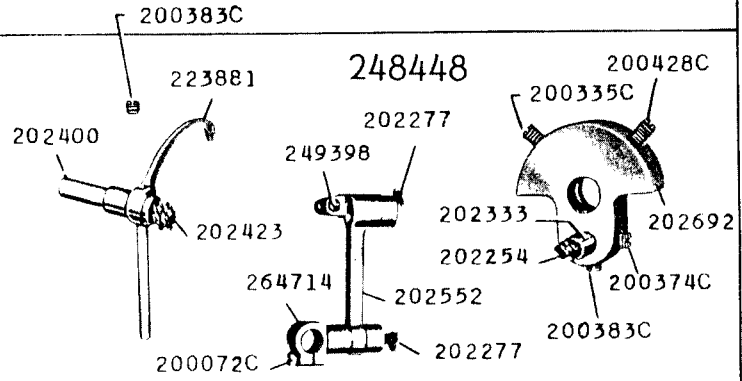

17817 - 3/8

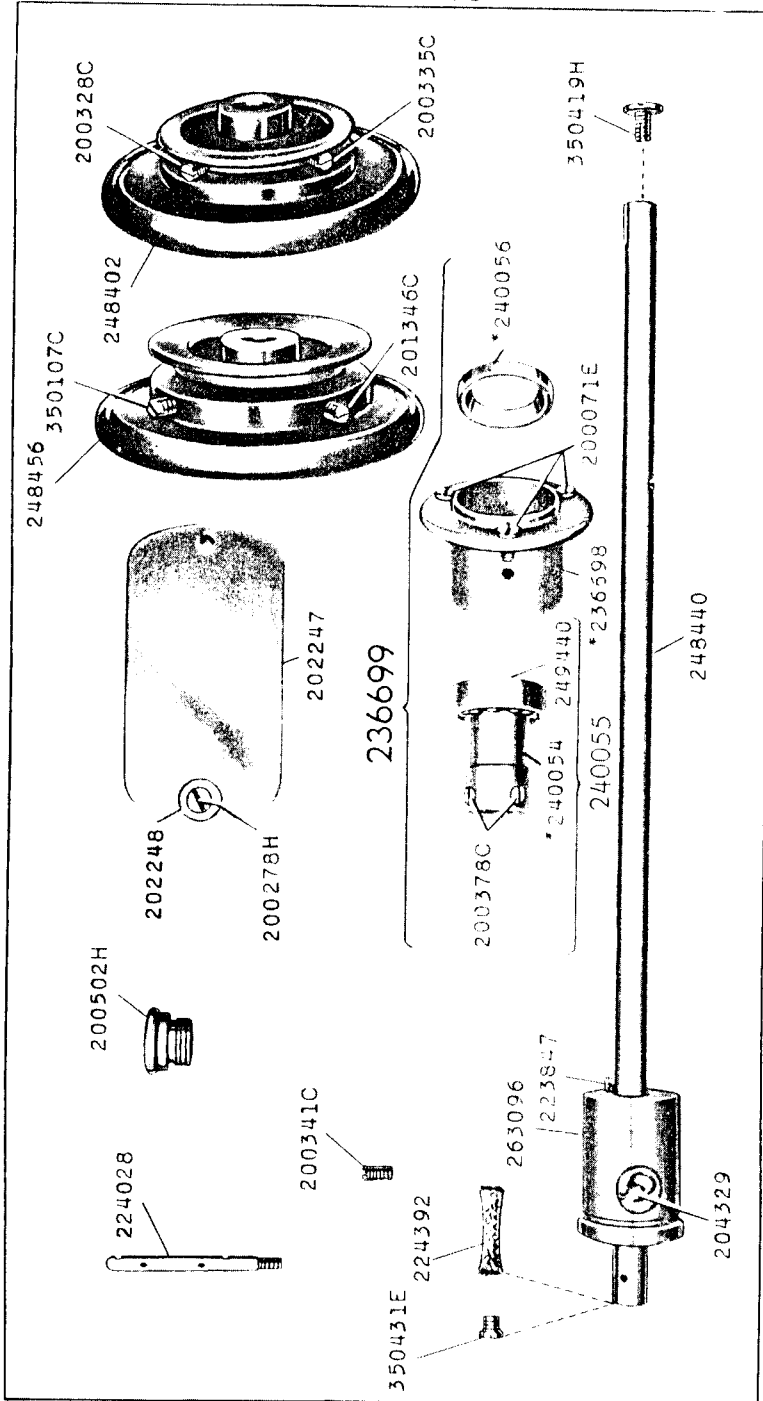

17818 - 1/2

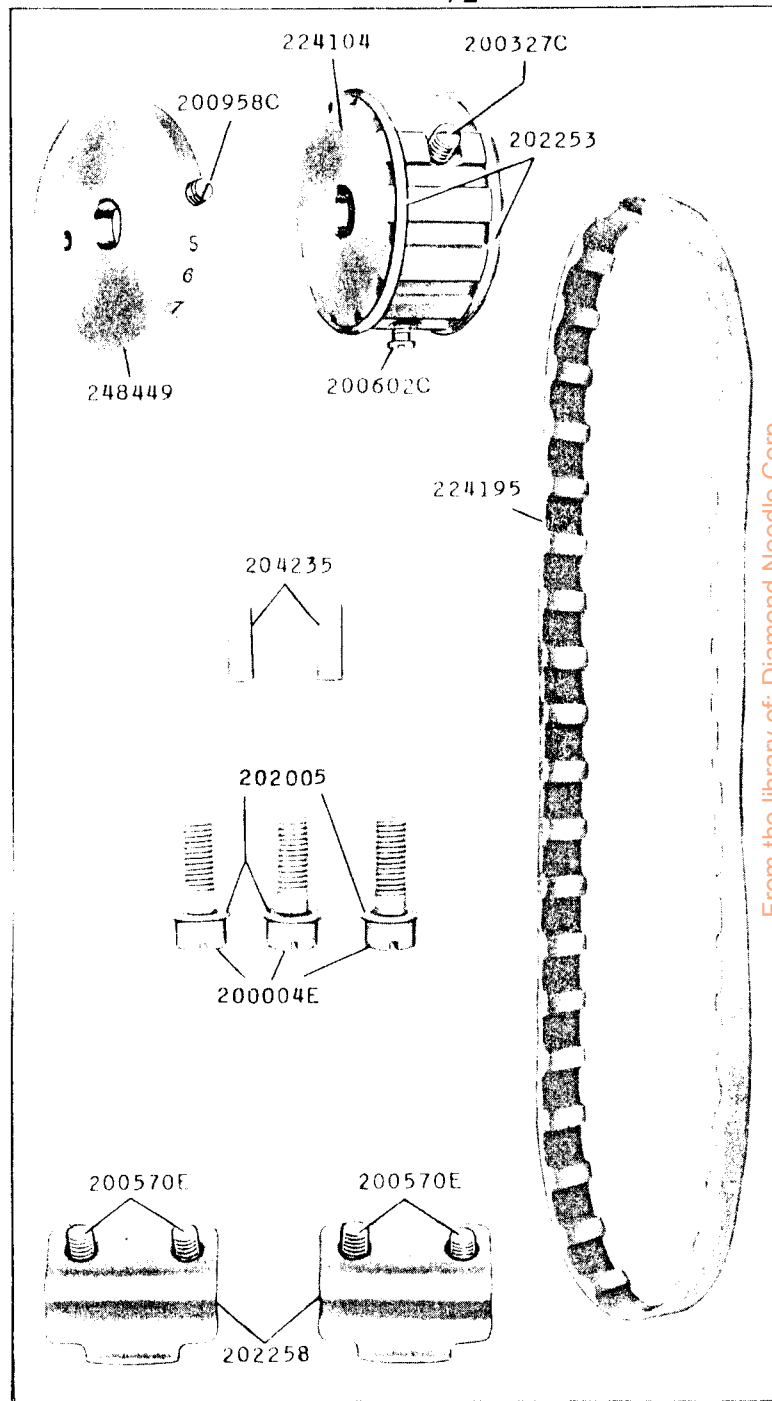

From the library of: Diamond Needle Corp

17819 - 2/3

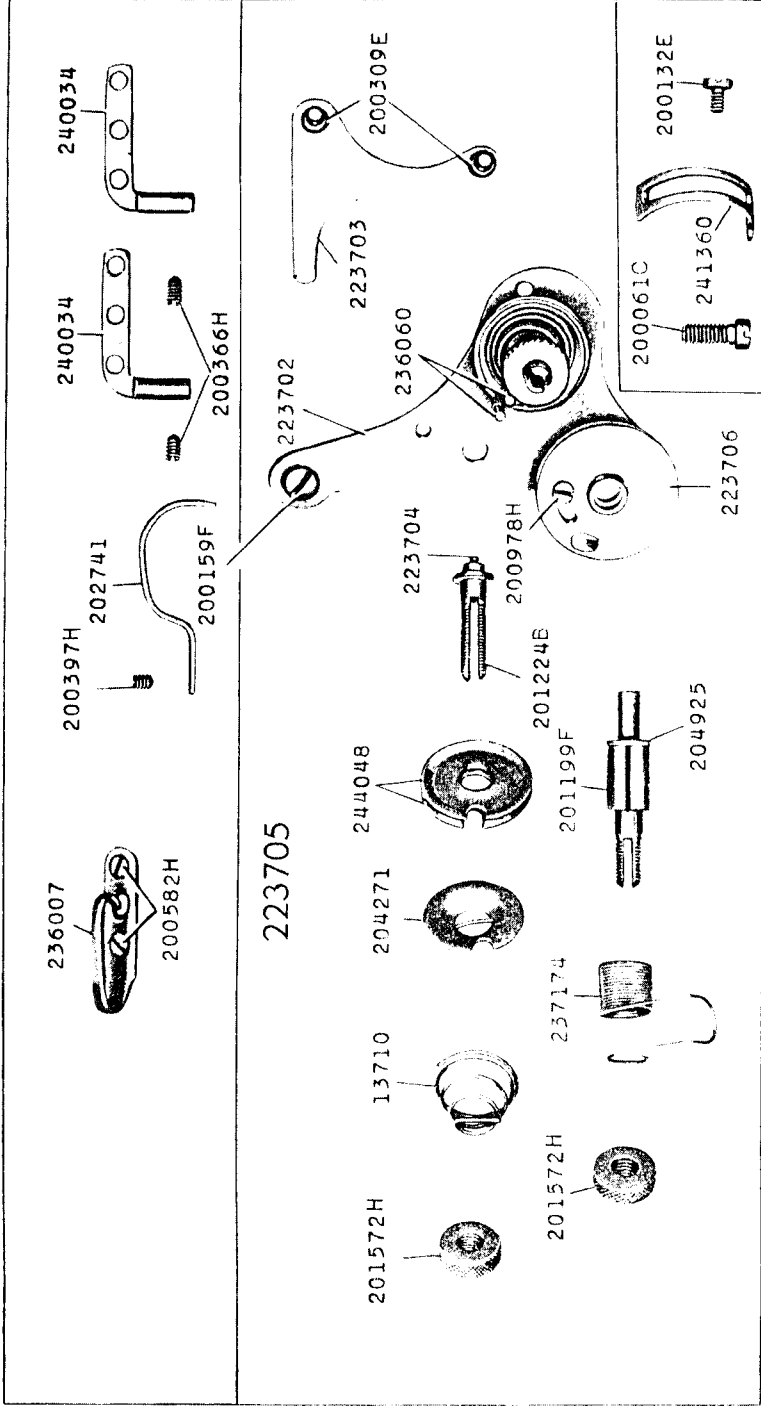

17820 - 1/2

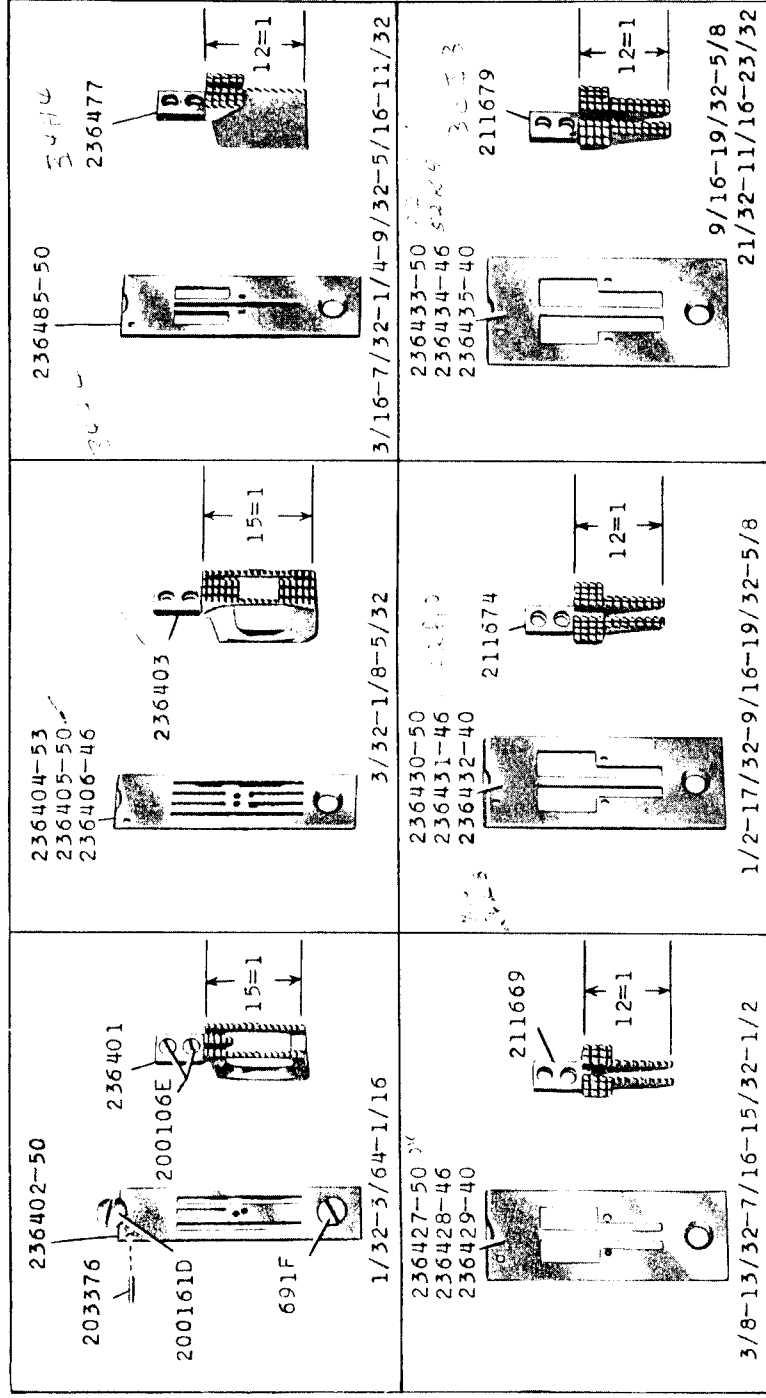





<p>236436-50 236437-46 236438-40</p> <p>203376 200161D 211685</p> <p>691F</p>	<p>236441-50 236442-46 236443-40</p> <p>236440</p> <p>13/16-27/32-7/8-29/32-15/16-31/32 1-1 1/32-1 1/16-1 5/32-1 1/8</p>	<p>236444-50 236445-46 236446-40</p> <p>211694</p> <p>1-1 1/32-1 1/16-1 3/32-1 1/8-1 5/32-1 3/16</p>
<p>236450-50 236451-46</p> <p>211698</p> <p>1 1/4-1 9/32-1 5/16</p>	<p>236454-50 236455-46</p> <p>236453</p> <p>1 3/8-1 13/32-1 7/16-1 15/32-1 1/2</p>	<p>236452-40 211739 236465 236472-50</p> <p>236465</p> <p>1/4-9/32-5/16-11/32 3/8-13/32-7/16-15/32 1/2</p>

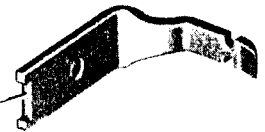

<p>236408-53 236409-50 236410-46-5/32 AND 3/16</p> <p>203376 200161D 212571 691F</p>	<p>236412-53 236413-50 236414-46-7/32 AND 1/4</p> <p>236411</p>	<p>236417-50 236465-46 236418-40</p> <p>236416</p> <p>7/32-1/4-9/32-5/16 11/32-3/8-13/32 7/16 1/4-9/32-5/16 11/32-3/8-13/32 7/16</p>
<p>236420-53 236421-50 236422-46</p> <p>236419</p> <p>9/32 AND 5/16</p>	<p>236424-53 236425-50 236426-46</p> <p>236423</p> <p>11/32 AND 3/8</p>	<p>236415 236470 236448-50 236449-40</p> <p>236447</p> <p>1 1/8-1 5/32-1 3/16-1 1/4</p>

<p>200161D 203376 691F</p> <p>236457-46 236456 236471</p> <p>200106E 12=1 22=1</p> <p>3/16-7/32-1/4 9/32-5/16-11/32-3/8</p>	<p>236459-50 236460-46 236461-40</p> <p>236458 16=1</p> <p>3/16-7/32-1/4-9/32-5/16</p>
<p>236467-53 1/8-5/32 AND 3/16</p> <p>236464 15=1</p> <p>236463-50-5/32 AND 3/16</p>	<p>236468-50 12=1</p> <p>236469</p> <p>1-1 1/32-1 1/16-1 3/32-1 1/8-1 5/32-1 3/16</p>

<p>229008-50 229092-50 229101-50 229559-50 229572-50</p> <p>1/32-3/64-1/16</p>	<p>229102-46 3/32-1/8-5/32 3/16-7/32</p>	<p>229103-46 1/4-9/32-5/16</p>	<p>229104-46 11/32-3/8-13/32 7/16-15/32-1/2</p>	<p>229105-46 17/32 AND 9/16</p>
<p>229106-46</p> <p>19/32-5/8-21/32-11/16</p>	<p>229107-46</p> <p>23/32 AND 3/4</p>	<p>229108-46 25/32-13/16-27/32-7/8 29/32-15/16-31/32-1/2</p>	<p>229110-46 1 1/32-1 1/16-1 3/32-1 1/8 1 5/32-1 3/16-1 7/32-1 1/4 1 9/32-1 5/16-1 11/32-1 3/8 1 13/32-1 7/16-1 15/32-1 1/2</p>	

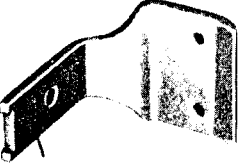
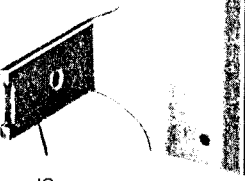
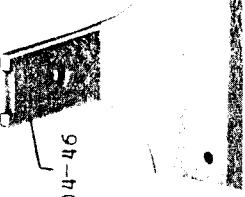
From the library of the National Archives and Records Administration

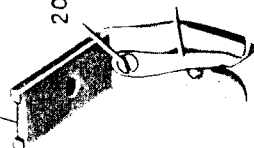
<p>222226-46</p>  <p>3/16-7/32-1/4</p>	<p>229542-46</p>  <p>200172H 229541</p> <p>1/8-5/32-3/16-7/32-1/4-9/32 5/16-11/32-3/8-13/32-7/16-15/16-1/2</p>	<p>229573-46</p>  <p>3/32-1/8-5/32 3/16-7/32-1/4</p>	<p>229575-46</p>  <p>9/32-5/16-11/32-3/8-13/32 7/16-15/32-1/2-17/32</p>
<p>229577-46</p>  <p>9/16-19/32-5/8 21/32-11/16-23/32</p>	<p>229578-46</p>  <p>3/4-25/32-13/16-27/32-7/8-29/32 15/16-31/32-1-1 1/32-1 1/16-1 3/32 1 1/8-1 5/32-1 3/16-1 7/32-1 1/4</p>	<p>229604-46</p>  <p>1 3/32-1 5/16-1 11/32-1 3/8-1 13/32 1 7/16-1 15/32-1 17/32-1 9/16-1 19/32 1 5/8-1 21/32-1 16-1 23/32-1 3/4</p>	

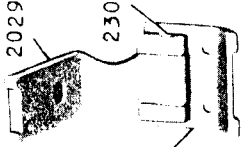
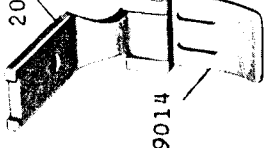
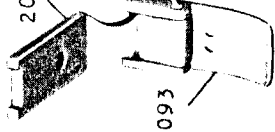
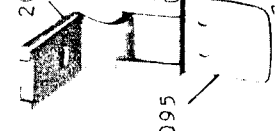
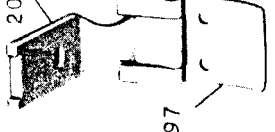
<p>224153-50</p>  <p>200175H 224150</p> <p>1/32-3/64-1/16</p>	<p>224148-46</p>  <p>200175H 224150</p> <p>3/32-1/8-5/32-3/16-7/32-1/4</p>	<p>229012 - 46</p>  <p>202926 230795</p> <p>229013</p> <p>15/32-1/2-17/32-9/16-19/32-5/8</p>	<p>229015 - 46</p>  <p>202923 230795</p> <p>229014</p> <p>17/32-9/16-19/32-5/8 21/32-11/16-23/32-3/4</p>
<p>229094 - 46</p>  <p>202923</p> <p>229093</p> <p>230795</p> <p>1/8-5/32-3/16</p>	<p>229096 - 46</p>  <p>202923</p> <p>229095</p> <p>230795</p> <p>7/32-1/4-9/32-5/16</p>	<p>229098 - 46</p>  <p>202923</p> <p>229097</p> <p>230795</p> <p>11/32-3/8-13/32-7/16</p>	

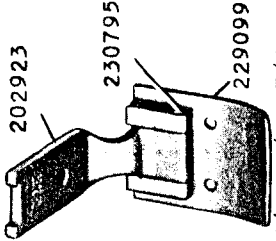
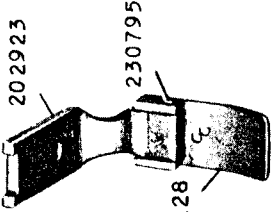
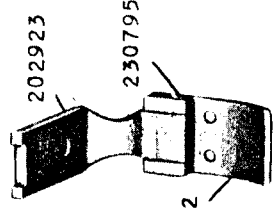
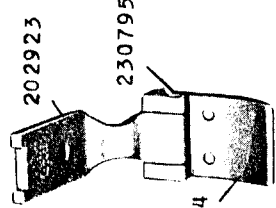
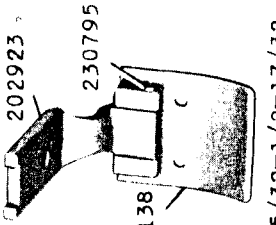
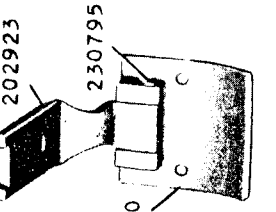
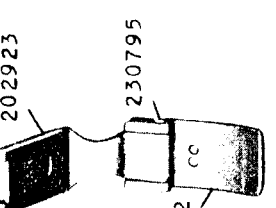
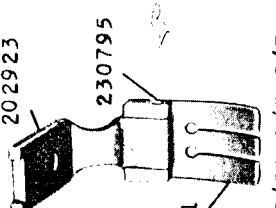
<p>229100 - 46</p>  <p>202923 230795 229099</p> <p>15/32-1/2-17/32 9/16-19/32-5/8</p>	<p>229129 - 50</p>  <p>202923 230795</p> <p>229128</p> <p>1/32-3/64-1/16</p>	<p>229133 - 46</p>  <p>202923 230795</p> <p>229132</p> <p>7/32-1/4-9/32-5/16</p>	<p>229135 - 46</p>  <p>202923 230795</p> <p>229134</p> <p>11/32-3/8-13/32-7/16</p>
<p>229139 - 46</p>  <p>202923 230795</p> <p>229138</p> <p>15/32-1/2-17/32 9/16-19/32-5/8</p>	<p>229141 - 46</p>  <p>202923 230795</p> <p>229140</p> <p>21/32-11/16-23/32-3/4</p>	<p>229163 - 50</p>  <p>202923 230795</p> <p>229162</p> <p>3/32-1/8-5/32-3/16</p>	<p>229262 - 46</p>  <p>202923 230795</p> <p>229261</p> <p>3/16-7/32-1/4-9/32 5/16-11/32-3/8</p>

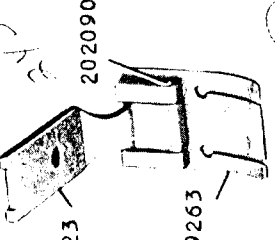
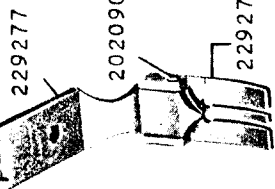
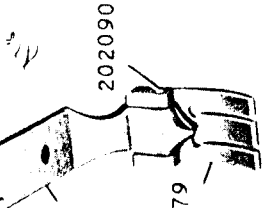
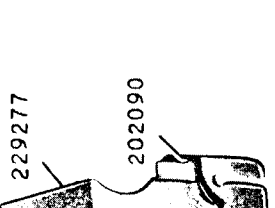
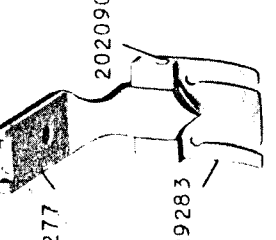
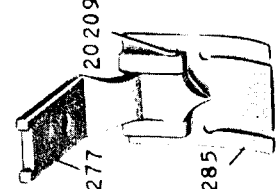
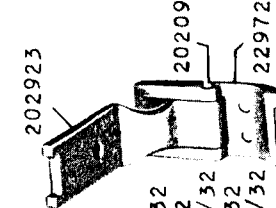
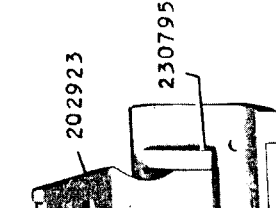
<p>229264 - 46</p>  <p>202923 202090</p> <p>229263</p> <p>13/32-7/16-15/32-1/2</p>	<p>229278 - 46</p>  <p>229277 202090</p> <p>229276</p> <p>1/8-5/32-3/16-7/32</p>	<p>229280 - 46</p>  <p>229277 202090</p> <p>229279</p> <p>1/4-9/32-5/16</p>	<p>229282 - 46</p>  <p>229277 202090</p> <p>229281</p> <p>11/32-3/8-13/32-7/16</p>
<p>229284 - 46</p>  <p>229277 202090</p> <p>229283</p> <p>1/2-17/32-9/16</p>	<p>229286 - 46</p>  <p>229277 202090</p> <p>229285</p> <p>19/32-5/8 21/32-11/16</p>	<p>230697 - 46</p>  <p>202923 202090</p> <p>229720</p> <p>3/16-7/32 1/4-9/32 5/16-11/32 3/8-13/32 7/16-15/32 1/2</p>	<p>230831 - 46</p>  <p>202923 230830</p> <p>230795</p> <p>3/4-25/32-13/16-27/32-7/8</p>

127

229935 - 46 202926 229184 230795 7/32-1/4-9/32-5/16	223901 - 50 202923 202090 223900 1/16	223904 - 50 202923 230795 223903 3/32-1/8-5/32-3/16	229167 - 46 202923 229195 230795 7/32-1/4-9/32-5/16
229169 - 46 202923 229168 230795 7/32-1/4-9/32-5/16	229188 - 46 202926 230795 229164 1/8-5/32-3/16	229192 - 50 202923 230795 229191 1/32-3/64-1/16	229194 - 46 202923 229193 230795 3/32-1/8-5/32-3/16

229198 - 46 202923 229197 230795 11/32-3/8-13/32-7/16	229202 - 46 202923 229201 230795 15/32-1/2-17/32 9/16-19/32-5/8	229204 - 46 202923 229203 230795 21/32-11/16-23/32-3/4	229216 - 46 202926 229215 230795 7/32-1/4-9/32-5/16
229218 - 46 202930 229217 230795 1/8-5/32-3/16	229322 - 46 202926 229321 230795 1/8-5/32-3/4-5/32-3/16	229369 - 46 202923 229368 230795 1/8-5/32-3/4-5/32-3/16	229561 - 46 202926 229560 230795 11/32-3/8-13/32-7/16

1/8-5/32-3/4-5/32-3/16 library of: Diana Olda Media Group

